

Consumer 2023



CADEL

Il calore al centro

Indice/Index Index/Inhalt

Spirit 5/5 Up ● 5,2 kW P. 14	Sound 5/7 Ps ● 5,5/7 kW P. 16	Sound 5/7 Up-Twin ● 5,5/7 kW P. 16	Hublot 6 Up-Twin ● 6 kW P.18 New	Magritte 6 ● 6 kW P.22 New	Grace 7/7 Up ● 7 kW P. 24	Cristal 7/7 Up ● 7 kW P. 26	Sweet 7 ● 7 kW P. 28	Perla 7 ● 7 kW P. 30	Luce Plus 9 ● 8,5 kW P. 32 New	Elle Plus 9 ● 8,5 kW P. 34 New	Cristal 9/Plus 9 ● 8,5 kW P. 38
Icon Plus 9 ● 8,5 kW P. 40	Quasimodo 9 Box/Up-Twin ● 9,3 kW P. 42	Zefiro 9 ● 9,3 kW P. 44	Frame 9/9 Up-Twin ● 9,3 kW P. 46	Shell 9 Ps/Up-Twin ● 9,1 kW P. 48	Tile Plus 10 ● 10 kW P. 50	Wall Plus 10 ● 10 kW P. 52	Prince 11/Plus 11 ● 10,5 kW P. 54	Kobe 11/Plus 11 ● 10,5 kW P. 56	Fenice 11/Plus 11 ● 10,5 kW P. 58	Mithos P. 12/14 Ps ● 12/14 kW P. 60	Mithos P. 12/14 Up ● 12/14 kW P. 60
Atena Plus 12/14 ● 12/14 kW P. 62	Idro Prince 12 ● 11,8 kW P. 64	River idrotech 18/24/24H2O ● 17,7/24,2 kW P. 66	River Idro 16/23 ● 16,1/22,4 kW P. 68	Saturno 16/24 ● 18/24,7 kW P. 70	Maya Idro 16/24 ● 16,1/22,4 kW P. 72	Idro Prince 30 ● 28,6 kW P. 74	Smart 60/80 ● 6,5/7,5 kW P. 76	Kook 60/80/90 ● 6,2/ 7,5 kW P. 78			

Pellet Air

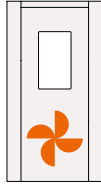

Cadel offre una gamma completa di stufe a pellet ventilate dotate di camera stagna per un maggior rendimento e minor consumo. Tutti i modelli di stufe Pellet Air sono certificati Classe Energetica A+, 4 stelle Aria Pulita™ o 5 stelle, 7 stelle Flamme Verte e sono riconosciuti come idonei a ricevere il rimborso Conto Termico.

Cadel offers a comprehensive range of ventilated air pellet stoves with a sealed chamber for greater efficiency and reduced consumption. All Pellet Air Stove models are conform with the EcoDesign 2022 directives.

Cadel propose une gamme complète de poêles à granulés à air ventilé équipés d'une chambre étanche pour un meilleur rendement et une moindre consommation. Tous les modèles de poêles Pellet Air sont certifiés 7 étoiles Flamme Vert et sont reconnus comme éligibles au crédit d'impôt. En outre, un an après leur introduction, ils sont référencés CSTB.

Cadel bietet eine vollständige Palette von Pelletöfen mit Gebläse und abgedichteter Brennkammer zur Gewährleistung von höherer Leistung und geringerem Verbrauch. Alle Pelletofen-Modelle der Linie Air sind Bimsch 2015 (Regensburg, München, Stuttgart, Aachen) und Klima Energiefonds zertifiziert.

Pellet Air Plus

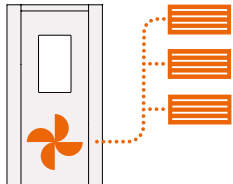

Per riscaldare più ambienti della casa in modo economico e pratico, la stufa a pellet canalizzabile Air Plus di Cadel è lo strumento ideale. Grazie al sistema di canalizzazione è possibile distribuire il calore rapidamente e in modo omogeneo anche in altre stanze. Tutti i modelli di stufe Pellet Air Plus sono certificati Classe Energetica A+, 4 o 5 stelle AriaPulita™, 7 stelle Flamme Verte e sono riconosciuti come idonei a ricevere il rimborso Conto Termico.

A Cadel Air Plus ductable pellet stove is the ideal tool to heat up several rooms in the house in a cost-effective and convenient way. Thanks to its ducting, you can distribute heat quickly and evenly in other rooms as well. All Pellet Air Plus Stove models are conform with the EcoDesign 2022 directives.

Pour chauffer plusieurs pièces de la maison de manière économique et pratique, le poêle à granulés canalisable Air Plus de Cadel est l'instrument idéal. Grâce au système de canalisation, il est possible de distribuer la chaleur rapidement et de façon homogène dans d'autres pièces aussi. Tous les modèles de poêles Pellet Air plus sont certifiés 7 étoiles Flamme Vert et sont reconnus comme éligibles au crédit d'impôt. En outre, un an après leur introduction, ils sont référencés CSTB.

Der kanalisierbare Pelletofen Air Plus von Cadel ist die ideale Lösung, um auf sparsame und praktische Weise mehrere Wohnräume zu erwärmen. Die Kanalisierung ermöglicht es, die Wärme rasch und gleichmäßig auch auf andere Räume zu verteilen. Alle Pelletofen-Modelle der Linie Air Plus sind Bimsch 2015 (Regensburg, München, Stuttgart, Aachen) und Klima Energiefonds zertifiziert.

Pellet Hydro

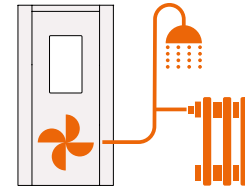

Le termostufe Cadel sono la soluzione ottimale per l'impianto di riscaldamento domestico, riscaldando rapidamente l'acqua dei termosifoni. Sono pratiche ed economiche ed uniscono la funzionalità ad un'estetica accattivante. Alcuni modelli sono disponibili nella versione H₂O: dotate di un apposito kit queste termostufe a pellet possono produrre acqua calda sanitaria.

Cadel thermostoves are an excellent solution for domestic heating systems, since they quickly heat water in the radiators, they are convenient and cost-effective, and combine functionality with a charming design. Some models are available in the H₂O version: equipped with a special kit, these pellet thermostoves can produce domestic hot water.

Les thermo-poêles Cadel sont une excellente solution pour le chauffage domestique, car ils chauffent rapidement l'eau des radiateurs, ils sont pratiques et économiques et allient fonctionnalité et aspect attrayant. Certains modèles sont disponibles dans la version H₂O : équipés d'un kit spécial, ces thermo-poêles à pellets peuvent produire de l'eau chaude sanitaire.

Die Thermoöfen von Cadel sind eine optimale Lösung für Wohnungsheizanlagen. Sie sorgen für eine schnelle Erwärmung des Wassers in den Heizkörpern, sind praktisch und wirtschaftlich und verbinden Funktionalität mit attraktiver Ästhetik. Einige Modelle sind auch in der Version H₂O erhältlich: Mit einem speziellen Bausatz ausgestattet können diese Pelletöfen auch das Warmwasser liefern.

Wood

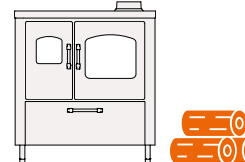

Conformi alle normative ambientali più severe, i prodotti a legna Cadel a libera installazione e da incasso uniscono il riscaldamento domestico, la versatilità installativa e l'estetica elegante. Grazie ad attente soluzioni costruttive, questi prodotti non necessitano di ulteriori kit per l'inserimento all'interno di un mobile cucina e le finiture curate permettono di poterle installare liberamente in qualsiasi ambiente.

Compliant with the strictest environmental regulations, Cadel's free and recessed installation wood products combine home heating with versatile installation and elegant aesthetics. Thanks to meticulous construction solutions, these products do not require additional kits for insertion in kitchen units and are well finished, which allows them to be easily installed in any room.

En conformité avec les réglementations environnementales les plus strictes, les produits à bois Cadel autonomes et encastrables allient le chauffage domestique, la polyvalence d'installation et l'esthétique élégante. Grâce à des solutions de construction soignées, ces produits ne nécessitent pas de kits supplémentaires pour l'insertion dans un meuble de cuisine, et les finitions raffinées permettent de les installer librement dans n'importe quelle pièce.

Die Holzgefeuerten Geräte von Cadel zur freistehenden Installation und zum Einbau vereinen in sich das Heizen der Wohnung, die Flexibilität bei der Installation und ein elegantes Design. Dank ihrer besonderen Bauart ist bei diesen Geräten kein zusätzlicher Bausatz für den Einbau in eine Küchenzeile erforderlich, und durch die edlen Oberflächen ist die Installation freistehend in jedem beliebigen Raum möglich.



● I nostri valori

Il calore al centro

Focus on heat
La chaleur au centre
Die Wärme im Mittelpunkt

Il calore è al centro dell'attività di Cadel che da oltre sessant'anni progetta e costruisce stufe di qualità. Lo fa interpretando le esigenze e i bisogni della famiglia contemporanea, mantenendo forte e inalterata la passione per un fuoco che sa scaldare, e non solo il corpo. Perché calore è fuoco, ma anche passione, emozione, convivialità; è il bello dell'accogliere nel proprio ambiente di vita. Cadel propone quindi una varietà di prodotti facilmente ambientabili, estremamente accessibili, facili nell'utilizzo, dal design distintivo eppur semplice. Un'azienda dall'anima di fuoco, solida, affidabile, che guarda al domani; un fuoco alimentato dalla passione di fare bene, con creatività e competenza, per mantenere vivo il valore internazionale del Made in Italy.

A focus on heat is what drives Cadel, which has been designing and manufacturing high-quality stoves for more than 60 years, in everything it does. It seeks to understand the needs and requirements of modern-day families while staying true to its passion for fire that keeps everything warm – not just our body. Warmth is not only about fire, it's also about passion, emotions and conviviality; it is the joy of welcoming people into your living environment. This is why Cadel offers a wide range of products that can be easily installed in any environment and are extremely accessible and easy to use, with a distinctive yet simple design. A company with a "soul of fire", which is solid, reliable, and forward-looking; a fire fuelled by the passion to succeed, with a creative approach and expertise, to uphold the prestige of Made in Italy quality worldwide.

La chaleur est au cœur de l'activité de Cadel, qui conçoit et fabrique des poêles de qualité depuis plus de soixante ans. Et ceci en interprétant les besoins et les exigences des familles modernes, tout en conservant une passion intense et inaltérée pour un feu qui sait réchauffer, et pas seulement le corps. Parce que la chaleur, c'est le feu, mais aussi la passion, l'émotion, la convivialité; c'est l'intérêt de l'hospitalité dans son propre cadre de vie. Cadel propose donc une gamme de produits faciles à mettre en place, extrêmement accessibles, faciles à utiliser, avec un design caractéristique mais simple. Une entreprise à l'« âme de feu », solide, fiable, tournée vers l'avenir; un feu alimenté par la passion de bien faire, avec créativité et savoir-faire, pour conserver la valeur internationale du Made in Italy.

Wärme ist das Herzstück des Unternehmens Cadel, das seit über sechzig Jahren Qualitätsöfen entwickelt und baut. Dabei interpretiert Cadel die Bedürfnisse und Anforderungen der Familie von Heute und bewahrt sich gleichzeitig eine starke und unveränderte Leidenschaft für ein Feuer, das nicht nur den Körper zu wärmen weiß. Denn Wärme ist Feuer, aber auch Leidenschaft, Emotion, Geselligkeit; sie ist die Schönheit des Willkommens in der eigenen Lebenswelt. Cadel bietet daher eine Reihe von Produkten an, die einfach an die Einrichtung anpassen, leicht zugänglich und benutzerfreundlich sind und über ein unverwechselbares, aber einfaches Design verfügen. Ein Unternehmen mit einer „Seele aus Feuer“, solide, zuverlässig und zukunftsorientiert; ein Feuer, das von der Leidenschaft genährt wird, mit Kreativität und Fachwissen Gutes zu tun, um den internationalen Wert des "Made in Italy" zu behalten.

Semplicemente funzionali. Le stufe proposte da Cadel rappresentano il perfetto connubio di forma e sostanza: uno stile "senza tempo", un design pulito, sempre attuale, che sposa la qualità e punta alla facilità di utilizzo e manutenzione, per soluzioni alla portata di tutti.

Simply functional. Cadel's stoves embody the perfect blend of form and substance: a timeless style, a clean and always fashionable design, which embraces quality and aims to create products that are easy to use and maintain, offering solutions that are suitable for all.

Tout simplement fonctionnels. Les poêles proposés par Cadel représentent la combinaison parfaite de la forme et de la substance: un style « intemporel », un design épuré, toujours actuel, qui épouse la qualité et qui met l'accent sur la facilité d'utilisation et d'entretien, pour des solutions à la portée de tous.

Einfach funktionell. Die Öfen von Cadel stellen die perfekte Verbindung von Form und Inhalt dar: Ein „zeitloser“ Stil, ein klares Design, immer auf dem neuesten Stand, das Qualität mit Benutzer- und Wartungsfreundlichkeit verbindet, für Lösungen, die für jeden erschwinglich sind.

Semplicità

Simplicity
Simplicité
Schlichtheit

Puntare alla affidabilità significa per Cadel effettuare una continua ricerca di innovazione tecnologica, sostenuta dalla lunga esperienza produttiva e commerciale, e offrire un servizio di customer service proattivo ed efficiente, per rispondere alle necessità di tutti.

For Cadel, aiming for reliability involves constantly striving for technological innovation, drawing on many years of experience in manufacturing and sales, and providing a proactive and efficient customer service in order to meet everybody's needs.

Pour Cadel, viser la fiabilité signifie mener une recherche continue d'innovation technologique, soutenue par une longue expérience productive et commerciale, et offrir un service client proactif et efficace, pour répondre aux besoins de tous.

Das Streben nach Zuverlässigkeit bedeutet für Cadel eine ständige Suche nach technologischer Innovation, unterstützt durch eine langjährige Erfahrung in der Herstellung und im Handel sowie einen proaktiven und effizienten Kundendienst, der den Bedürfnissen aller gerecht wird.

Reliability
Fiabilité
Zuverlässigkeit

Affidabilità

Cadel crede nella convenienza non solo proponendo stufe dagli standard performanti, durevoli nel tempo a prezzi accessibili, ma anche ponendo attenzione alla piena corrispondenza tra funzione, uso e consumo, a garanzia dell'ambiente e per il bene di tutti.

Cadel firmly believes in affordability, and does so not only by offering high-performance, long-lasting stoves at reasonable prices, but also by ensuring consistency between function, use and consumption, for the sake of the environment and for the benefit of everyone.

Cadel croit en des prix avantageux non seulement en proposant des poêles répondant à des normes de performance élevées, de longue durée et à des prix abordables, mais aussi en prêtant attention à la correspondance complète entre fonctions, utilisation et consommation, afin de protéger l'environnement et pour le bien de tous.

Cadel setzt auf Komfort, wobei nicht nur leistungsstarke und langlebige Öfen zu erschwinglichen Preisen angeboten werden, sondern auch auf die vollständige Übereinstimmung zwischen Funktion, Nutzung und Verbrauch geachtet wird, um die Umwelt zu schützen und zum Wohle aller.

Convenienza

Affordability
Rapport qualité-prix
Preis-Leistungsverhältnis

Nuove Tecnologie

Flexit

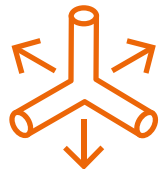

La tecnologia Flexit garantisce un'ottima **flessibilità in termini di installazione**, sia per quanto concerne l'uscita dei fumi (possono essere posteriori, superiori, superiori-concentriche) che quelle d'aria calda canalizzabile (posteriori o superiori).

The Flexit technology guarantees excellent **flexibility in terms of installation**, with regards to smoke outlet – which can be rear, top, top-concentric – as well as with regards to ductable hot air (rear or top).

La technologie Flexit garantit une excellente **flexibilité en termes d'installation**, aussi bien en ce qui concerne les sorties des fumées (elles peuvent être postérieures, supérieures, supérieures-concentriques) que celles de l'air chaud canalisable (postérieures ou supérieures).

Die Flexit-Technologie bietet eine hervorragende **Flexibilität bei der Installation**, sowohl hinsichtlich des Rauchgasabzugs (hinten, oben, oben-konzentrisch) als auch bezüglich des kanalisierten Auslasses von Warmluft (hinten oder oben).

Possibilità di uscita fumi superiore con kit Ø 80 o con kit Ø 130 coassiali.
Upper smoke outlet option with kit Ø 80 or with kit Ø130 coaxial. / Option sortie de fumées supérieure avec kit Ø 80 ou avec kit Ø130 coaxial. Obere Rauchgasauslass Option mit Kit Ø 80 oder mit Kit Ø130 koaxial.

Possibilità di canalizzazione aria posteriore o superiore.
Rear and upper air canalisation option. Option canalisation air postérieure et supérieure. Option hintere und obere Luft-Kanalisierung

Uscita fumi.
Smoke outlet. Sortie de fumées. Rauchgasauslass.

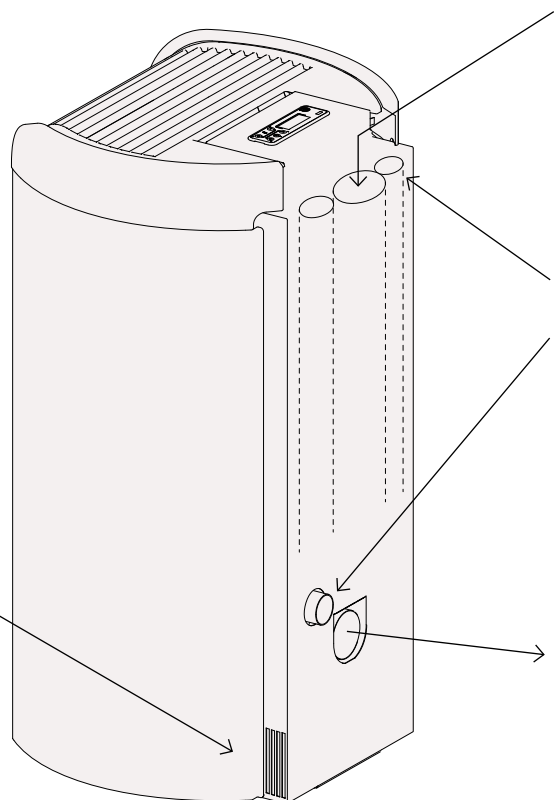

Sui modelli Plus ventilazione laterale di serie. / Standard side ventilation on Plus Models. Ventilation latérale standard sur les modèles Plus. Standard seitliche Belüftung bei Plus Modellen.

Idrotech



Idrotech è l'innovativo sistema di **pulizia automatica del braciere** che asporta automaticamente i depositi di cenere nel braciere ed evita pertanto la pulizia giornaliera del focolare. È previsto un raschiamento meccanico del braciere ad intervalli regolari e al rilevamento di un intasamento di cenere. In questo modo la combustione è sempre perfetta ed efficiente.

Idrotech is the innovative **automatic brazier cleaning** system that automatically removes ash deposits in the brazier and therefore does away with daily firebox cleaning. Mechanical scraping of the brazier is carried out at regular intervals and whenever ash clogging is detected. In this way, combustion is always perfect and efficient.

Idrotech est le système innovant de **nettoyage automatique du brasero** qui élimine automatiquement les dépôts de cendres dans le brasero en évitant ainsi de devoir nettoyer le foyer tous les jours. Un raclage mécanique du brasero est prévu à intervalles réguliers et en cas de détection d'une obstruction par la cendre. De cette façon, la combustion est toujours parfaite et efficace.

Idrotech ist das innovative **automatische Brennschalen-reinigungssystem**, das Ascheablagerungen in der Brennschale automatisch entfernt und somit eine tägliche Reinigung der Brennkammer vermeidet. Es sieht in regelmäßigen Abständen und bei Feststellen von Ascheverstopfung ein mechanisches Abschaben der Brennschale vor. Auf diese Weise ist die Verbrennung immer perfekt und effizient.

Go Fast



Sistema costituito da una candeletta/resistenza di tipo ceramico che garantisce un'**accensione più rapida del pellet** e un consumo di elettricità inferiore rispetto alle tradizionali resistenze in metallo. Questa tipologia di resistenza ha inoltre una maggiore durata nel tempo grazie alla migliore tenuta all'ossidazione e alla corrosione naturale e chimica.

System consisting of a ceramic type glow plug/resistor that guarantees **faster pellet ignition** and lower electricity consumption than the conventional metal resistor. This type of resistor also has a longer service life thanks to better resistance to oxidation and to natural and chemical corrosion.

Système constitué d'une bougie de préchauffage/résistance de type céramique qui garantit un **allumage plus rapide du pellet** et une consommation d'électricité inférieure par rapport aux résistances traditionnelles en métal. Ce type de résistance a par ailleurs une plus grande durée dans le temps grâce à la meilleure résistance à l'oxydation et à la corrosion naturelle et chimique.

Das System besteht aus einer keramischen Zündkerze/Widerstand, die eine **schnellere Zündung der Pellets** und einen geringeren Stromverbrauch als herkömmliche Metallwiderstände gewährleistet. Diese Art von Widerstand hat zudem eine längere Lebensdauer, da sie besser gegen Oxidation und natürliche und chemische Korrosion beständig ist.

Plus Cadel

Comfort mode



Disattiva automaticamente i ventilatori della stufa a potenza 1, per garantire la **massima silenziosità**. Di fabbrica la funzione Comfort Mode è sempre attiva per tutte le stufe a pellet. È disattivabile dall'utente solamente sulle stufe canalizzabili e hydro. Quando il Comfort mode è attivo, con stufa in potenza 1 e ventilatori impostati in automatico (A), la ventilazione è spenta per tutti i motori (sia ambiente che di canalizzazione).

This automatically deactivates the stove fans to power 1 to guarantee **maximum silence**. The Comfort Mode function is activated as standard on all pellet stoves. Users can deactivate it only on ductable and hydro stoves. When the Comfort mode is activated, with the stove set to power 1 and fans set to automatic (A), ventilation is off for all motors (both room and ducting ventilation).

Les ventilateurs sont automatiquement désactivés quand le poêle est à la puissance 1, afin de garantir un **maximum de silence**. Par défaut, la fonction Comfort Mode est toujours activée pour tous les poêles à pellets. Elle ne peut être désactivée par l'utilisateur que sur les poêles canalisables et les poêles hydro. Lorsque le Comfort mode est activé, avec le poêle en puissance 1 et les ventilateurs réglés sur automatique (A), la ventilation est éteinte pour tous les moteurs (aussi bien ambiante que de canalisation).

Automatische Deaktivierung der Gebläse des Ofens auf Stufe 1, um einen **sehr leisen Betrieb** zu gewährleisten. Standardmäßig ist die Funktion Komfortmodus bei allen Pelletöfen immer aktiv. Sie kann vom Benutzer nur bei kanalisierten Öfen und Hydro-Öfen ausgeschaltet werden. Wenn der Komfortmodus aktiv ist, der Ofen auf Leistung 1 geschaltet ist und die Gebläse auf Automatik (A) eingestellt sind, wird die Lüftung für alle Motoren (Raum und Luftkanal.) ausgeschaltet.

Ventilatori indipendenti



Grazie al sistema di canalizzazione dell'aria, con le stufe Air Plus è possibile distribuire il **calore in modo omogeneo in più stanze**. A seconda delle esigenze abbiamo stufe canalizzabili a due o tre uscite: tutti i ventilatori di canalizzazione possono essere gestiti in modo autonomo.

Independent fans
Thanks to the air ducting system of the Air Plus stoves, heat can be evenly distributed in several rooms. Depending on your needs, we have ductable stoves with two or three outlets: all fans can be controlled separately.

Ventilateurs indépendants
Grâce au système de canalisation de l'air, les poêles Air Plus permettent de distribuer la chaleur de façon homogène dans plusieurs pièces. En fonction des besoins, il est possible d'opter pour un poêle canalisable à deux ou trois sorties : tous les ventilateurs peuvent être gérés de manière autonome.

Unabhängige Gebläse
Die Kanalisierung ermöglicht es bei den Air Plus Öfen, die Wärme rasch und gleichmäßig in mehreren Räumen zu verteilen. Je nach Bedarf bieten wir Öfen mit zwei oder drei Luftauslässen an: Hier können alle Gebläse unabhängig gesteuert werden.

Camera stagna



Stufe a pellet **totalmente ermetiche** rispetto all'ambiente d'installazione: prelevano l'aria di combustione dall'esterno e non dal locale in cui sono installate. Meno emissioni, più sicurezza, maggior rendimento.

Sealed chamber

Pellet stoves that are completely sealed in relation to the room of installation: they draw combustion air directly from outdoors and not from the room they are installed in.

- Fewer emissions
- More safety
- Greater efficiency

Chambre étanche

Ces poêles à pellets sont parfaitement hermétiques par rapport à l'environnement d'installation : ils prélèvent l'air de combustion de l'extérieur directement et non pas du local dans lequel ils sont installés.

- Moins d'émissions
- Plus de sécurité
- Meilleur rendement

Abgedichtete kammer

Vollkommen gegen die Installationsumgebung abgedichtet: Die Verbrennungsluft wird direkt von außen angesaugt, nicht aus dem Raum, in dem der Ofen installiert ist.

- Weniger Emissionen
- Mehr Sicherheit
- Höherer Wirkungsgrad

5 stelle



Cadel aderisce allo schema di **certificazione AriaPulita™**, che permette di valutare le stufe in base al rendimento energetico che offrono e le emissioni che producono. Raggiungono le 5 stelle AriaPulita™ stufe e inserti a pellet che garantiscono emissioni di polvere ridotte dell'80% rispetto agli apparecchi che hanno ottenuto 1 stella.

Cadel adheres to the **AriaPulita™ certification** scheme, which evaluates stoves based on their energy performance and on their emissions. Pellet stoves and inserts that guarantee 80% lower particulate emissions than appliances that have obtained 1 star are awarded 5 AriaPulita™ stars.

Cadel adhère au système de **certification AriaPulita™** qui permet d'évaluer les poêles en fonction du rendement énergétique qu'ils offrent et des émissions qu'ils produisent. Les poêles et inserts à pellet AriaPulita™ qui atteignent 5 étoiles, garantissent des émissions de poussière réduites de 80 % par rapport aux appareils ayant obtenu 1 étoile.

Cadel hält sich an das System **der AriaPulita™-Zertifizierung**, welches die Öfen nach ihrer Energieeffizienz und Emissionen bewertet. Die AriaPulita™-5-Sterne-Einstufung für Pelletöfen und -einsätze reduziert die Staubemissionen im Vergleich zu 1-Sterne-Geräten um 80 %.



● Wi-Fi & Bluetooth
Easy Connect Plus

Per una stufa sempre connessa e intelligente

Con l'app **Easy Connect Plus**, e le tecnologie **Wi-Fi** e **Bluetooth** integrate, puoi accendere, programmare, controllare e spegnere tutte le stufe CADEL direttamente dal tuo smartphone, ovunque tu sia. In una sola schermata puoi controllare e gestire le funzioni principali, impostando tempi e temperatura desiderata per ottimizzare i consumi e migliorare il comfort.

For a smart stove connected at all times

Thanks to the **Easy Connect Plus** app, and the built-in **Wi-Fi** and **Bluetooth** technologies, you can turn on, set up, control and turn off all CADEL stoves easily using your smartphone – wherever you are. From a single screen, you can access and control the main features and set on/off times and the desired temperature for optimal consumption and greater comfort

Pour un poêle toujours connecté et intelligent

Grâce à l'application **Easy Connect Plus** et aux technologies **Wi-Fi** et **Bluetooth** intégrés, vous pouvez allumer, programmer, contrôler et éteindre tous les poêles CADEL depuis votre smartphone, où que vous soyez. Une seule page vous permet de contrôler et gérer les fonctions principales, régler les durées et la température souhaitée, afin d'optimiser les consommations et améliorer le confort.

Für einen stets verbundenen und intelligenten Ofen

Mit der App **Easy Connect Plus** und den integrierten **WLAN** - und **Bluetooth**-Technologien können Sie alle Öfen von CADEL direkt von Ihrem Smartphone einschalten, programmieren, steuern und ausschalten, wo immer Sie sich gerade befinden. Von einer einzigen Ansicht aus können Sie die wichtigsten Funktionen steuern und verwalten und die Betriebszeiten und die gewünschte Temperatur einstellen. So können Sie den Verbrauch optimieren und den Wärmekomfort nach Ihren Wünschen gestalten.



Informazioni

Una panoramica sullo stato di funzionamento della stufa, in relazione alle funzioni e regolazioni attive.

Information

An overview of the stove's operating status in relation to active functions and adjustments.

Informations

Un aperçu de l'état de fonctionnement du poêle, en ce qui concerne les fonctions et réglages activés.

Informationen

Eine Übersicht über den Betriebsstatus des Ofens je nach den aktivierten Funktionen und Regulierungen.



Regolazioni

Regolazione potenza, temperatura ambiente, canalizzazione, ventilazione e Eco Stop. Nelle stufe idro controllo della temperatura dell'acqua per Caldaia e Puffer.

Adjustments

Power, room temperature, ducting, ventilation and Eco Stop adjustment. Boiler and Puffer water temperature can be controlled in hydro stoves.

Réglages

Réglage de la puissance, de la température ambiante, des canalisations, de la ventilation et de la fonction Eco Stop. Contrôle de la température de l'eau de la chaudière et du ballon tampon des poêles hydro.

Regulierungen

Regulierung der Leistung, der Raumtemperatur, der Luftkanalisierung und der Ventilation sowie Eco Stop. Bei den wasserführenden Öfen Temperaturkontrolle von Kessel und Pufferspeicher.

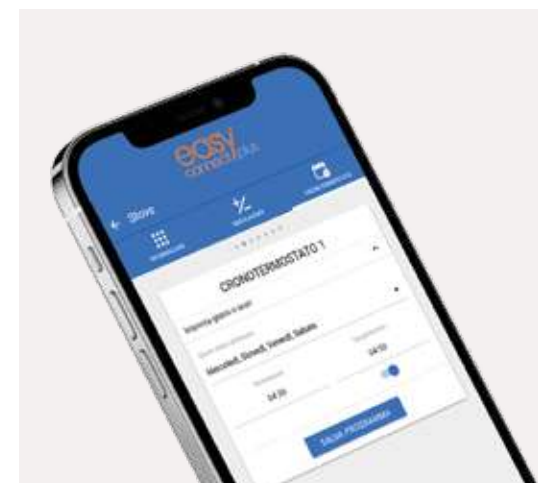

Cronotermostato

Programmazione per l'accensione e lo spegnimento della stufa in base alle esigenze di comfort.

Programmable thermostat

Programme the stove to switch on or off as needed for your comfort.

Thermostat programmable

Programmation pour allumer et éteindre le poêle en fonction des besoins de confort.

Zeitthermostat

Programmierung zum Ein- und Ausschalten des Ofens je nach gewünschtem Wärmekomfort.



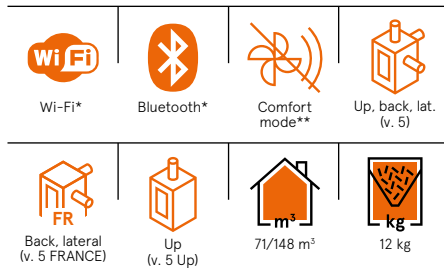

*** Gestione tramite Wi-Fi e Bluetooth integrati**
Control through integrated Wi-Fi and Bluetooth
Gestion via Wi-Fi et Bluetooth intégrés
Verwaltung über WLAN und integriertes Bluetooth

**** Disattiva i ventilatori per garantire la massima silenziosità**
Deactivates stove fans, to guarantee maximum silence/Désactivez les ventilateurs afin de garantir le maximum de silence/Deaktivierung der Gebläse, um maximale Ruhe zu gewährleisten

5,2 kW



Spirit 5



Spirit 5 Up

Scopri le caratteristiche del prodotto e il tuo risparmio con il conto termico

Spirit 5/5 Up

Upgrade

- **Forme snelle e compatte dal design moderno**
- **Porta e braciere in ghisa**
- **Scarico fumi superiore, posteriore o laterale**



- Slim and compact shapes with a modern design
- Cast iron door and burning pot
- Upper, back or lateral exhaust

- Formes élancées et compactes au design moderne
- Porte et brasero en fonte
- Sortie des fumées supérieure, postérieure ou latérale

- Schlanke und kompakte Formen mit modernem Design
- Tür und Brennschale aus Gusseisen
- Rauchgasabzug oben, hinten oder seitlich

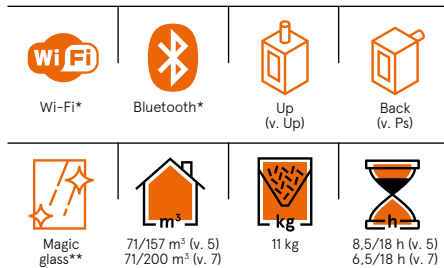

* **Gestione tramite Wi-Fi e Bluetooth integrati**
Control through integrated Wi-Fi and Bluetooth
Gestion via Wi-Fi et Bluetooth intégrés
Verwaltung über WLAN und integriertes Bluetooth

** **Vetro oscurato Magic Glass a stufa spenta**
Magic Glass tinted glass when the stove is off
Vitre obscurcie Magic Glass lorsque le poêle est éteint/Getönte Magic Glas Glasscheibe bei ausgeschaltetem Ofen

5,5/
7 kW



Sound 5 Ps



Sound 7 Ps



Sound 5 Up-Twin



Sound 7 Up-Twin

Scopri le **caratteristiche del prodotto** e il tuo risparmio con il **conto termico**

Sound 5/7 Ps/Up-Twin



- **Stufa tonda dal design moderno**
- **Top e base in ghisa**
- **Vetro Magic Glass**

- Round stove with a modern design
- Cast iron top and base
- Magic glass

- Poêle rond au design moderne
- Couvercle et base en fonte
- Vitre Magic Glass

- Runder Ofen mit modernem Design
- Topplatte und Sockel aus Gusseisen
- Magic-Glass-Glasscheibe

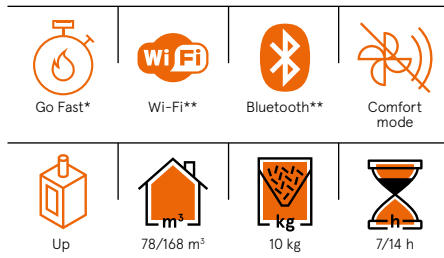

*** Candeletta di tipo ceramico che garantisce un'accensione più rapida del pellet**
Glow plug that guarantees faster pellet ignition
Bougie de préchauffage de type céramique qui garantit un allumage plus rapide du pellet
Keramischen Zündkerze stand, die eine schnellere Zündung der Pellets

**** Gestione tramite Wi-Fi e Bluetooth integrati**
Control through integrated Wi-Fi and Bluetooth
Gestion via Wi-Fi et Bluetooth intégrés
Verwaltung über WLAN und integriertes Bluetooth

6 kW



Scopri le caratteristiche del prodotto e il tuo risparmio con il conto termico

- Small and compact pellet stove with a wide view of the flame
- Large 'porthole' door, top, grill and feet are made of cast iron
- Front ventilation
- It is perfect to be installed in an existing firebox

- Petit et compact, ce poêle à granulés a une large vue sur la flamme
- Grande porte à hublot, couvercle, grille et pieds en fonte
- Ventilation frontale
- Parfait pour être installé dans une cheminée existante

- Kleiner und kompakter Pelletofen mit einer weiten Sicht auf die Flamme
- Große 'Bullaugen'-Tür, Topplatte, Grillrost und Füße aus Gusseisen
- Frontale Gebläse
- Ist perfekt fürs Einbau in einem bestehenden Kamin



Hublot 6 Up-Twin

New

- Piccola e compatta, con ampia visione della fiamma
- Grande porta "oblò", top, griglia e piedini in ghisa
- Ventilazione frontale
- Perfetta per essere installata in un focolare esistente





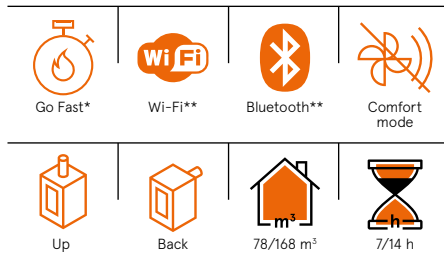

*** Candeletta di tipo ceramico che garantisce un'accensione più rapida del pellet**
 Glow plug that guarantees faster pellet ignition
 Bougie de préchauffage de type céramique qui garantit un allumage plus rapide du pellet
 Keramischen Zündkerze stand, die eine schnellere Zündung der Pellets

**** Gestione tramite Wi-Fi e Bluetooth integrati**
 Control through integrated Wi-Fi and Bluetooth
 Gestion via Wi-Fi et Bluetooth intégrés
 Verwaltung über WLAN und integriertes Bluetooth

6 kW



Scopri le caratteristiche del prodotto e il tuo risparmio con il conto termico

Magritte 6

New

- Stufa a pellet compatta e dal design contemporaneo
- La grande porta in ghisa esalta la visione del fuoco
- Porta, top, griglia e base in ghisa
- Ventilazione frontale
- Perfetta per essere installata in un focolare esistente



- Compact, contemporary-designed pellet stove
- The large cast-iron door enhances the view of the fire
- Door, top, grill and base are made of cast iron
- Front ventilation
- It is perfect to be installed in an existing firebox

- Poêle à granulés compact au design contemporain
- La grande porte en fonte met en valeur la vue sur le feu
- Porte, couvercle, grille et base sont en fonte
- Ventilation frontale
- Parfait à installer dans une cheminée existante

- Kompakter Pelletofen mit einer weiten Sicht auf die Flamme
- Die große Tür aus Gusseisen ermöglicht ein optimale Sicht auf das Feuer
- Tür, Topplatte, Grillrost und Füße aus Gusseise
- Frontale Gebläse
- Ist perfekt fürs Einbau in einen bestehenden Kamin

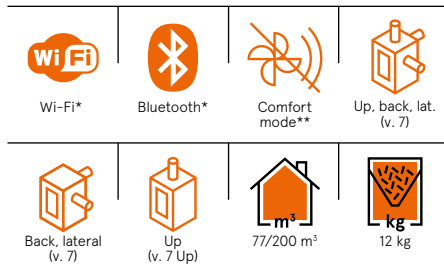

*** Gestione tramite Wi-Fi e Bluetooth integrati**
Control through integrated Wi-Fi and Bluetooth
Gestion via Wi-Fi et Bluetooth intégrés
Verwaltung über WLAN und integriertes Bluetooth

**** Disattiva i ventilatori per garantire la massima silenziosità**
Deactivates stove fans, to guarantee maximum silence/Désactivez les ventilateurs afin de garantir le maximum de silence/Deaktivierung der Gebläse, um maximale Ruhe zu gewährleisten

7 kW



Grace 7



Grace 7 Up

Scopri le caratteristiche del prodotto e il tuo risparmio con il conto termico

Grace 7/7 Up

Upgrade

- Design elegante e contemporaneo
- Soli 27,5 cm di profondità, per gli spazi ristretti
- Possibilità di installazione a parete o sospesa



- Elegant and contemporary design
- Only 27.5 cm deep, for confined spaces
- Possibility of wall or suspended installation

- Design élégant et contemporain
- Seulement 27,5 cm de profondeur pour les espaces réduits
- Possibilité d'installation au mur ou suspendue

- Elegantes und zeitgenössisches Design
- Nur 27,5 cm Tiefe, für enge Platzverhältnisse
- Möglichkeit der Installation an der Wand oder hängend



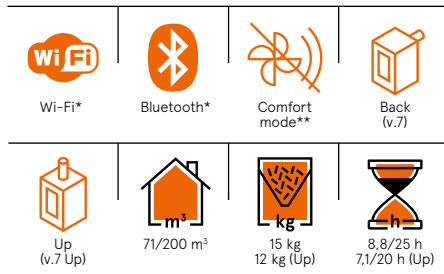

*** Gestione tramite Wi-Fi e Bluetooth integrati**
Control through integrated Wi-Fi and Bluetooth
Gestion via Wi-Fi et Bluetooth intégrés
Verwaltung über WLAN und integriertes Bluetooth

**** Disattiva i ventilatori per garantire la massima silenziosità**
Deactivates stove fans, to guarantee maximum silence/Désactivez les ventilateurs afin de garantir le maximum de silence/Deaktivierung der Gebläse, um maximale Ruhe zu gewährleisten

7 kW



Cristal 7



Cristal 7 Up

Scopri le **caratteristiche del prodotto** e il tuo risparmio con il **conto termico**

Cristal 7/7 Up



- **Essenziale e funzionale**
- **Ottimo rapporto qualità prezzo**
- **Wi-Fi e bluetooth inclusi**

- Essential and functional
- Great value for money
- Wi-Fi and Bluetooth included

- Essentiel et fonctionnel
- Rapport qualité-prix excellent
- Wi-Fi et Bluetooth inclus

- Wesentlich und funktionell
- Ausgezeichnetes Preis-Leistungs-Verhältnis
- Integrierte WLAN und Bluetooth



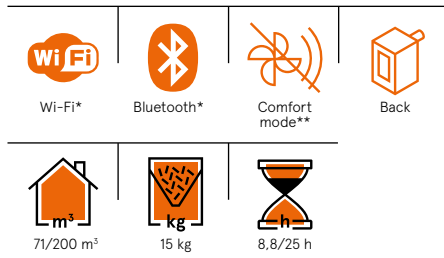

*** Gestione tramite Wi-Fi e Bluetooth integrati**
Control through integrated Wi-Fi and Bluetooth
Gestion via Wi-Fi et Bluetooth intégrés
Verwaltung über WLAN und integriertes Bluetooth

**** Disattiva i ventilatori per garantire la massima silenziosità**
Deactivates stove fans, to guarantee maximum silence/Désactivez les ventilateurs afin de garantir le maximum de silence/Deaktivierung der Gebläse, um maximale Ruhe zu gewährleisten

7 kW



Scopri le caratteristiche del prodotto e il tuo risparmio con il conto termico

Sweet 7

- Look pulito e moderno
- Semplicità d'uso
- Wi-Fi e Bluetooth incluso

- Clean and modern look
- Easy to use
- Wi-Fi and Bluetooth included

- Look soigné et modern
- Simplicité d'utilisation
- Wi-Fi et Bluetooth inclus

- Sauberes und modernes Aussehen
- Einfache Nutzung
- Integrierte WLAN und Bluetooth



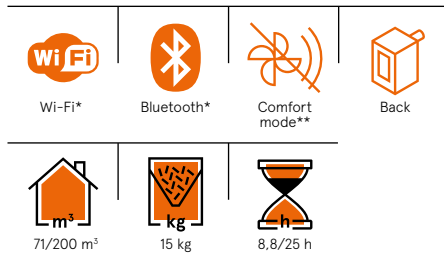

*** Gestione tramite Wi-Fi e Bluetooth integrati**
Control through integrated Wi-Fi and Bluetooth
Gestion via Wi-Fi et Bluetooth intégrés
Verwaltung über WLAN und integriertes Bluetooth

**** Disattiva i ventilatori per garantire la massima silenziosità**
Deactivates stove fans, to guarantee maximum silence/Désactivez les ventilateurs afin de garantir le maximum de silence/Deaktivierung der Gebläse, um maximale Ruhe zu gewährleisten

7 kW



Scopri le caratteristiche del prodotto e il tuo risparmio con il conto termico

- Classic design
- Cast iron burning pot and top
- Wide range of steel and high-quality ceramic claddings

- Design classique
- Couvercle et brasero en fonte
- Large gamme d'habillages en acier et céramique raffinée

- Klassisches Design
- Topplatte und Brennschale aus Gusseisen
- Große Palette an Verkleidungen aus Stahl oder Keramik



Perla 7



- Design classico
- Top e braciere in ghisa
- Ampia gamma di rivestimenti, sia in acciaio che in ceramica pregiata



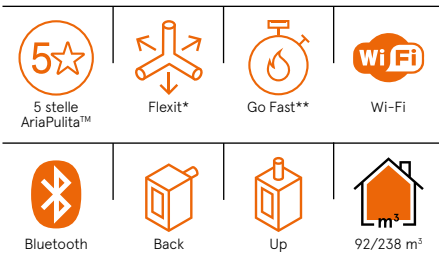

*** Flessibilità di installazione (uscita dei fumi e aria calda canalizzabile)**
Flexibility in terms of installation (smoke outlet and ductable hot air)
Flexibilité en termes d'installation (sorties des fumées et air chaud canalisable)/Flexibilität bei der Installation (Rauchgasabzugs und kanalisierbaren von Warmluft)

**** Candeletta di tipo ceramico che garantisce un'accensione più rapida del pellet**
Glow plug that guarantees faster pellet ignition
Bougie de préchauffage de type céramique qui garantit un allumage plus rapide du pellet
Keramischen Zündkerze stand, die eine schnellere Zündung der Pellets

8,5 kW



Scopri le caratteristiche del prodotto e il tuo risparmio con il conto termico

- Modern, slim and space saving
- Rear and upper exhaust: coaxial as optional
- Lower front grill
- Flexit

- Moderne, étroit et peu encombrant
- Sortie des fumées postérieure et supérieure, coaxial en opt.
- Avec une grille frontale
- Flexit

- Modern und platzsparend
- Rauchabgas hinten und oben, Koaxial als Option
- Warme Luft kommt auch vom unteren Gitter
- Flexit



Luce Plus 9



New

- **Moderna, compatta e salvaspazio**
- **Scarico fumi: posteriore e superiore, coassiale optional**
- **Dotata di griglia frontale inferiore per l'uscita dell'aria**
- **Flexit**



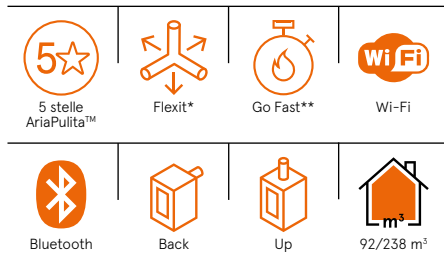

*** Flessibilità di installazione (uscita dei fumi e aria calda canalizzabile)**
Flexibility in terms of installation (smoke outlet and ductable hot air)
Flexibilité en termes d'installation (sorties des fumées et air chaud canalisable)/Flexibilität bei der Installation (Rauchgasabzugs und kanalisierbaren von Warmluft)

**** Candeletta di tipo ceramico che garantisce un'accensione più rapida del pellet**
Glow plug that guarantees faster pellet ignition
Bougie de préchauffage de type céramique qui garantit un allumage plus rapide du pellet
Keramischen Zündkerze stand, die eine schnellere Zündung der Pellets

8,5 kW



Scopri le caratteristiche del prodotto e il tuo risparmio con il conto termico

- Contemporary and elegant, with a steel and glass frame
- Essential and material, enhanced by the front panel made of stone
- Flexit

- Contemporain et élégant, avec un cadre en acier
- Essentiel et matérieque, rehaussé par l'habillage en pierre
- Flexit

- Zeitgemäß und elegant, mit einem Stahlrahmen
- Wesentlich und materisch, aufgewertet durch einen stimmungsvollen Seitenteil aus Stein.
- Flexit



Elle Plus 9

New

- Contemporanea ed elegante, con cornice in acciaio e vetro
- Disponibile con frontale in Gres Porcellanato: Pietra Nero Greco ed Ossido Bruno
- Flexit





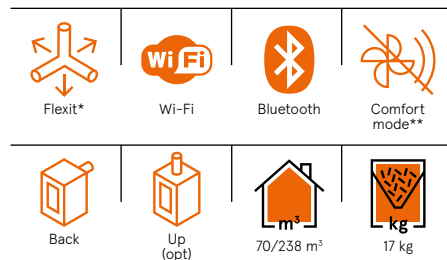

*** Flessibilità di installazione (uscita dei fumi e aria calda canalizzabile)**
Flexibility in terms of installation (smoke outlet and ductable hot air)
Flexibilité en termes d'installation (sorties des fumées et air chaud canalisable)/Flexibilität bei der Installation (Rauchgasabzug und kanalisierbaren von Warmluft)

**** Disattiva i ventilatori per garantire la massima silenziosità**
Deactivates stove fans, to guarantee maximum silence/Désactivez les ventilateurs afin de garantir le maximum de silence/Deaktivierung der Gebläse, um maximale Ruhe zu gewährleisten

8,5 kW



Cristal 9



Cristal Plus 9

Scopri le caratteristiche del prodotto e il tuo risparmio con il conto termico

Cristal 9 Cristal Plus 9



- Canalizzabile
- Porta in ghisa diamantata e bombata
- Top piatto
- Flexit
- 4 stelle AriaPulita™ ma con emissioni polveri da 5 stelle

- Ductable
- Bevelled and diamond-shaped cast iron door
- Flat top
- Flexit

- Canalisable
- Porte en fonte à section biseautée et convexe
- Couvercle plat
- Flexit

- Kanalisierbar
- Mit Diamantschliff bearbeitete und gewölbte Tür aus Gusseisen
- Flache Topplatte
- Flexit



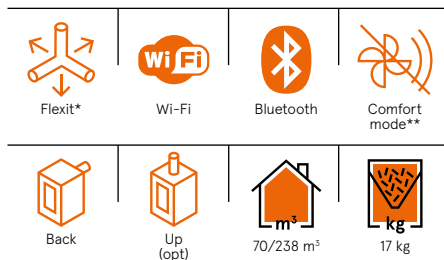

*** Flessibilità di installazione (uscita dei fumi e aria calda canalizzabile)**
Flexibility in terms of installation (smoke outlet and ductable hot air)
Flexibilité en termes d'installation (sorties des fumées et air chaud canalisable)/Flexibilität bei der Installation (Rauchgasabzugs und kanalisierbaren von Warmluft)

****Disattiva i ventilatori per garantire la massima silenziosità**
Deactivates stove fans, to guarantee maximum silence/Désactivez les ventilateurs afin de garantir le maximum de silence/Deaktivierung der Gebläse, um maximale Ruhe zu gewährleisten

8,5 kW



Scopri le caratteristiche del prodotto e il tuo risparmio con il conto termico

Icon Plus 9

- Design moderno e linee semplici
- Canalizzabile
- Originale top in ghisa
- Elegante porta in vetro
- 4 stelle AriaPulita™ ma con emissioni polveri da 5 stelle
- Flexit



- Modern design and neat lines
- Ductable
- Unique cast iron top
- Elegant glass door
- Flexit

- Design moderne et lignes simples
- Canalisable
- Couvercle original en fonte
- Élégante porte vitrée
- Flexit

- Modernes Design und einfache Linien
- Kanalisierbar
- Original-Topplatte aus Gusseisen
- Elegante Glastür
- Flexit

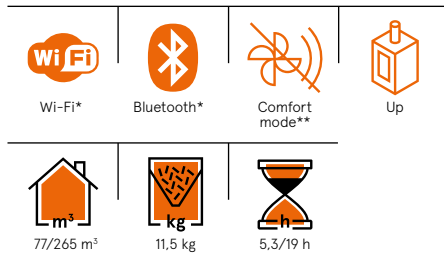

*** Gestione tramite Wi-Fi e Bluetooth integrati**
Control through integrated Wi-Fi and Bluetooth
Gestion via Wi-Fi et Bluetooth intégrés
Verwaltung über WLAN und integriertes Bluetooth

**** Disattiva i ventilatori per garantire la massima silenziosità**
Deactivates stove fans, to guarantee maximum silence/Désactivez les ventilateurs afin de garantir le maximum de silence/Deaktivierung der Gebläse, um maximale Ruhe zu gewährleisten

9,3 kW



Scopri le caratteristiche del prodotto e il tuo risparmio con il conto termico

Quasimodo 9 Box/Up-Twin



- Powerful and airtight stove
- A simple shape that decorates
- Wide glass door and cast-iron firebox
- Poêle puissant et étanche
- Une forme essentielle qui décore
- Grande porte vitrée et foyer en fonte
- Leistungsstarker Ofen mit luftdichter Brennkammer
- Eine wesentliche Form, die einrichtet und dekoriert
- Große Glastür und gusseiserner Brennkammer

- **Stufa potente ed ermetica**
- **Una forma essenziale che arreda**
- **Ampia porta in vetro e focolare in ghisa**



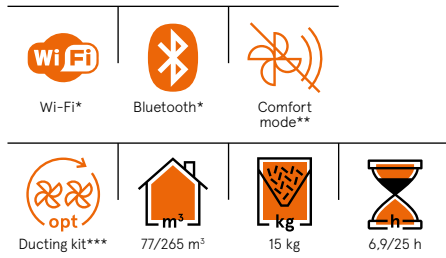

*** Gestione tramite Wi-Fi e Bluetooth integrati**
Control through integrated Wi-Fi and Bluetooth
Gestion via Wi-Fi et Bluetooth intégrés
Verwaltung über WLAN und integriertes Bluetooth

garantir le maximum de silence/Deaktivierung der Gebläse, um maximale Ruhe zu gewährleisten

**** Disattiva i ventilatori per garantire la massima silenziosità**
Deactivates stove fans, to guarantee maximum silence/Désactivez les ventilateurs afin de

***** Kit canalizzazione (opzionale)**
Ducting kit (optional)
Kit conduits de canalisation (opt.)
Kit für Kanalisierung (optional)

9,3 kW



Scopri le caratteristiche del prodotto e il tuo risparmio con il conto termico

Zefiro 9



- Insetto che offre una bella visione della fiamma
- Perfetto per camini esistenti
- Possibilità di canalizzazione con Kit opzionale

- Large glass window for a better view of the flame
- Fits perfectly to existing fireplaces
- Ducting available with optional kit

- Insert qui offre une belle vue sur la flamme
- Parfait pour les cheminées existantes
- Solutions de canalisation avec kit en option

- Einsatz mit guter Sicht auf die Flamme
- Perfekt für bereit bestehende Kamine
- Möglichkeit der Luftkanalisierung durch optionales Zubehörset

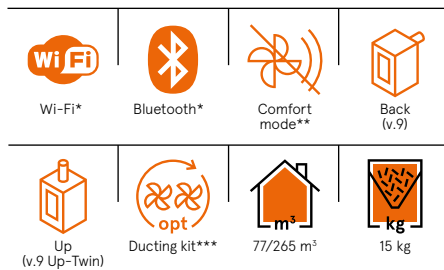

*** Gestione tramite Wi-Fi e Bluetooth integrati**
Control through integrated Wi-Fi and Bluetooth
Gestion via Wi-Fi et Bluetooth intégrés
Verwaltung über WLAN und integriertes Bluetooth

garantir le maximum de silence/Deaktivierung der Gebläse, um maximale Ruhe zu gewährleisten

***** Kit canalizzazione (opzionale)**
Ducting kit (optional)
Kit conduits de canalisation (opt.)
Kit für Kanalisierung (optional)

**** Disattiva i ventilatori per garantire la massima silenziosità**
Deactivates stove fans, to guarantee maximum silence/Désactivez les ventilateurs afin de

9,3 kW



Frame 9



Frame 9 Up-Twin

Scopri le caratteristiche del prodotto e il tuo risparmio con il conto termico

Frame 9/9 Up-Twin

- Raffinata e metropolitana
- Ampio vetro per una panoramica visione della fiamma
- Possibilità di canalizzazione con Kit opzionale



- Sophisticated and metropolitan
- Wide glass for a panoramic view of the flame
- Ducting available with optional kit
- Élégant et métropolitain
- Large vitre pour une vue panoramique de la flamme
- Solutions de canalisation avec kit en option
- Raffiniert und zeitgenössisch
- Großes Glas für einen Panoramablick auf die Flamme
- Möglichkeit der Luftkanalisierung durch optionales Zubehörset



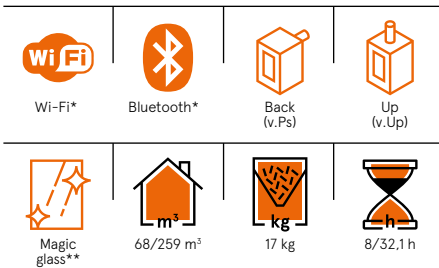

*** Gestione tramite Wi-Fi e Bluetooth integrati**
Control through integrated Wi-Fi and Bluetooth
Gestion via Wi-Fi et Bluetooth intégrés
Verwaltung über WLAN und integriertes Bluetooth

**** Vetro oscurato Magic Glass a stufa spenta**
Magic Glass tinted glass when the stove is off
Vitre obscurie Magic Glass lorsque le poêle est éteint/Getönte Magic Glas Glasscheibe bei ausgeschaltetem Ofen

9,1 kW



Shell 9 Ps



Shell 9 Up-Twin

Scopri le caratteristiche del prodotto e il tuo risparmio con il conto termico

Shell 9 Ps/Up-Twin



- Linee morbide e materiali high tech
- Vetro oscurato Magic Glass a stufa spenta
- Scarico fumi posteriore o superiore

- Soft lines and high-tech materials
- Magic Glass tinted glass when the stove is off
- Upper or back exhaust

- Lignes souples et matériaux high tech
- Vitre obscurie Magic Glass lorsque le poêle est éteint
- Sortie des fumées postérieure ou supérieure

- Weiche Linien und High-Tech-Materialien
- Getönte Magic Glas Glasscheibe bei ausgeschaltetem Ofen
- Rauchgasabzug hinten oder oben

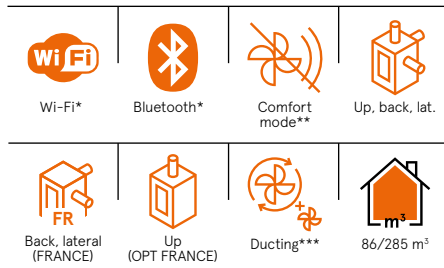

*** Gestione tramite Wi-Fi e Bluetooth integrati**
Control through integrated Wi-Fi and Bluetooth
Gestion via Wi-Fi et Bluetooth intégrés
Verwaltung über WLAN und integriertes Bluetooth

**** Disattiva i ventilatori per garantire la massima silenziosità**
Deactivates stove fans, to guarantee maximum silence/Désactivez les ventilateurs afin de

garantir le maximum de silence/Deaktivierung der Gebläse, um maximale Ruhe zu gewährleisten

***** Canalizzazione 1 motore indipendente**
Duction with 1 independent motor
Conduits d'aération avec 1 moteur indépendant
Kanalisierung mit 1 unabhängigen Luftgebläse

10 kW



Scopri le **caratteristiche del prodotto** e il tuo risparmio con il **conto termico**

- Elegant shape
- Only 27 cm deep, for confined spaces
- Upper, back and lateral exhaust

- Forme élégante
- Seulement 27 cm de profondeur, pour les petits espaces
- Sortie des fumées supérieure, postérieure ou latérale

- Elegante Form
- Nur 27 cm Tiefe, für enge Platzverhältnisse
- Rauchgasabzug oben, hinten oder seitlich



Tile Plus 10



- Forma elegante
- Soli 27 cm di profondità, per gli spazi ristretti
- Scarico fumi superiore, posteriore o laterale

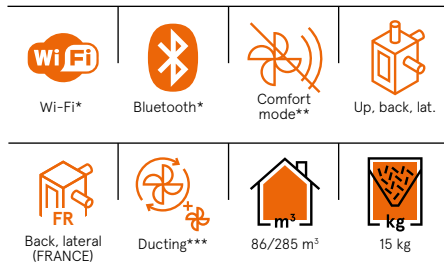

*** Gestione tramite Wi-Fi e Bluetooth integrati**
Control through integrated Wi-Fi and Bluetooth
Gestion via Wi-Fi et Bluetooth intégrés
Verwaltung über WLAN und integriertes Bluetooth

**** Disattiva i ventilatori per garantire la massima silenziosità**
Deactivates stove fans, to guarantee maximum silence/Désactivez les ventilateurs afin de

garantir le maximum de silence/Deaktivierung der Gebläse, um maximale Ruhe zu gewährleisten

***** Canalizzazione 1 motore indipendente**
Duction with 1 independent motor
Conduits d'aération avec 1 moteur indépendant
Kanalisierung mit 1 unabhängigen Luftgebläse

10 kW



Scopri le **caratteristiche del prodotto** e il tuo risparmio con il **conto termico**

- Minimalist design
- Only 29 cm deep, for confined spaces
- Perfect for small walls, corridors or to be suspended

- Design minimaliste
- Seulement 29 cm de profondeur, pour les petits espaces
- Parfait pour des murs de petite largeur, des couloirs ou l'installation suspendue

- Minimalistisches Design
- Nur 29 cm Tiefe, für enge Platzverhältnisse
- Perfekt für kleine Wände, Flure oder zum Aufhängen



Wall Plus 10



- Design minimale
- Soli 29 cm di profondità, per gli spazi ristretti
- Perfetta per piccole pareti, corridoi o sospesa

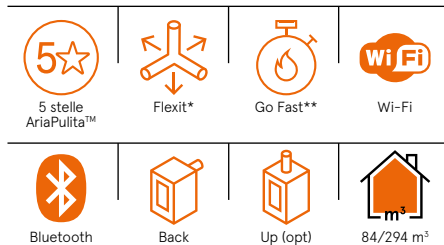

*** Flessibilità di installazione (uscita dei fumi e aria calda canalizzabile)**
Flexibility in terms of installation (smoke outlet and ductable hot air)
Flexibilité en termes d'installation (sorties des fumées et air chaud canalisable)/Flexibilität bei der Installation (Rauchgasabzugs und kanalisierbaren von Warmluft)

**** Candeletta di tipo ceramico che garantisce un'accensione più rapida del pellet**
Glow plug that guarantees faster pellet ignition
Bougie de préchauffage de type céramique qui garantit un allumage plus rapide du pellet
Keramischen Zündkerze stand, die eine schnellere Zündung der Pellets

10,5 kW



Prince 11



Prince Plus 11

Scopri le caratteristiche del prodotto e il tuo risparmio con il conto termico

Prince 11 Prince Plus 11



- Canalizzabile
- Restyling contemporaneo del modello evergreen
- Forma squadrata impresiosita da un'elegante cornice bicolore
- 5 stelle AriaPulita™
- Flexit



- Ductable
- Contemporary restyling of an evergreen model
- Squared lines enriched by an elegant bicolor frame
- Flexit

- Canalisable
- Restyling contemporain d' un modèle evergreen
- Forme carrée enrichie par un élégant cadre bicolore
- Flexit

- Kanalisierbar
- Zeitgemäßes Restyling eines Evergreen
- Quadratische Form mit elegantem zweifarbigem Rahmen
- Flexit

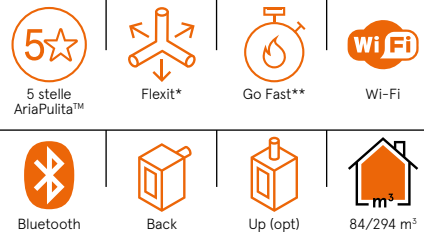

*** Flessibilità di installazione (uscita dei fumi e aria calda canalizzabile)**
Flexibility in terms of installation (smoke outlet and ductable hot air)
Flexibilité en termes d'installation (sorties des fumées et air chaud canalisable)/Flexibilität bei der Installation (Rauchgasabzugs und kanalisierbaren von Warmluft)

**** Candeletta di tipo ceramico che garantisce un'accensione più rapida del pellet**
Glow plug that guarantees faster pellet ignition
Bougie de préchauffage de type céramique qui garantit un allumage plus rapide du pellet
Keramischen Zündkerze stand, die eine schnellere Zündung der Pellets

10,5 kW



Kobe 11



Kobe Plus 11

Scopri le caratteristiche del prodotto e il tuo risparmio con il conto termico

Kobe 11 Kobe Plus 11

- Canalizzabile
- Ampia scelta di colori per la cornice frontale
- Ampia visione della fiamma
- Top dal design innovativo per una canalizzazione versatile
- 5 stelle AriaPulita™
- Flexit



- Ductable
- Wide choice of colours for the front frame
- Wide view of the flame
- Innovatively designed top for versatile ducting
- Flexit

- Canalisable
- Large choix de couleurs pour le cadre frontal
- Grande vision de la flamme
- Couvercle au design innovant pour une canalisation polyvalente
- Flexit

- Kanalisierbar
- Große Auswahl an Farben für den Frontrahmen
- Gute Sicht auf die Flamme
- Topplatte mit innovativem Design für eine vielseitige Kanalisierung
- Flexit



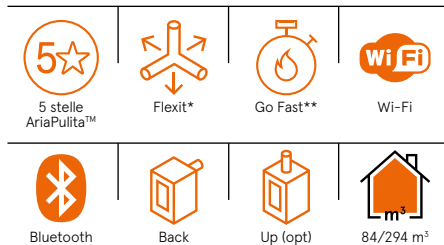

*** Flessibilità di installazione (uscita dei fumi e aria calda canalizzabile)**
Flexibility in terms of installation (smoke outlet and ductable hot air)
Flexibilité en termes d'installation (sorties des fumées et air chaud canalisable)/Flexibilität bei der Installation (Rauchgasabzug und kanalisierbaren von Warmluft)

**** Candeletta di tipo ceramico che garantisce un'accensione più rapida del pellet**
Glow plug that guarantees faster pellet ignition
Bougie de préchauffage de type céramique qui garantit un allumage plus rapide du pellet
Keramischen Zündkerze stand, die eine schnellere Zündung der Pellets

10,5 kW



Fenice 11



Fenice Plus 11

Scopri le **caratteristiche del prodotto** e il tuo risparmio con il **conto termico**

Fenice 11 Fenice Plus 11



- Canalizzabile
- L'arte che arreda e riscalda, perfetto complemento d'arredo dalla grande personalità
- Struttura dalla forma curva con top anello dalle finiture preziose
- 5 stelle AriaPulita™
- Flexit



- Ductable
- Art that furnishes and heats, a perfect interior design item with a great personality
- Structure with curved shape and ring top with precious finishes
- Flexit

- Canalisable
- L'art qui meuble et qui chauffe, le mobilier de complément idéal, affichant une grande personnalité
- Structure à la forme ronde avec un couvercle en forme d'anneau aux finitions précieuses
- Flexit

- Kanalisierbar
- Kunst, die einrichtet und wärmt, der perfekte Einrichtungsgegenstand mit Charakter
- Abgerundete Struktur mit edler Ring-Topplatte
- Flexit

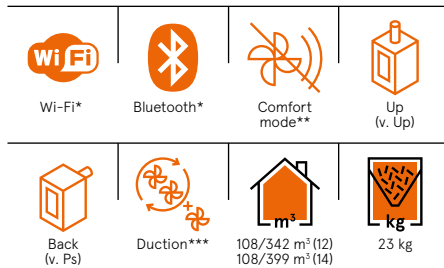

*** Gestione tramite Wi-Fi e Bluetooth integrati**
Control through integrated Wi-Fi and Bluetooth
Gestion via Wi-Fi et Bluetooth intégrés
Verwaltung über WLAN und integriertes Bluetooth

garantir le maximum de silence/Deaktivierung der Gebläse, um maximale Ruhe zu gewährleisten

**** Disattiva i ventilatori per garantire la massima silenziosità**
Deactivates stove fans, to guarantee maximum silence/Désactivez les ventilateurs afin de

***** Canalizzazione 2 motori indipendenti**
Duction with 2 independ. motors
Conduits d'aération avec 2 moteurs indépendants
Kanalisierung mit 2 unabhängigen Luftgebläsen

12/
14 kW



Mithos Plus 12 Ps



Mithos Plus 14 Ps



Mithos Plus 12 Up-Twin



Mithos Plus 14 Up-Twin

Scopri le **caratteristiche del prodotto** e il tuo risparmio con il **conto termico**

Mithos Plus 12/14 Ps/Up-Twin

- Design minimal e molteplici soluzioni installative
- Griglie di ventilazione frontali inferiori e migliore distribuzione dell'aria
- Wi-Fi e Bluetooth integrati



- Minimal design and multiple installation solutions
- Lower front ventilation grilles and improved air distribution
- Built-in Wi-Fi and Bluetooth

- Design minimaliste et multiples solutions d'installation
- Grilles de ventilation frontales dans le bas et meilleure distribution de l'air
- Wi-Fi et Bluetooth intégrés

- Minimalistisches Design und viele Installationsmöglichkeiten
- Belüftungsgitter vorn unten und bessere Verteilung der Luft
- Integriertes WLAN und Bluetooth



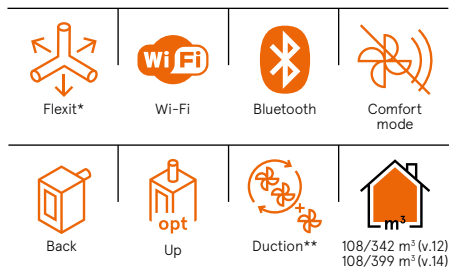

*** Flessibilità di installazione (uscita dei fumi e aria calda canalizzabile)**
Flexibility in terms of installation (smoke outlet and ductable hot air)
Flexibilité en termes d'installation (sorties des fumées et air chaud canalisable)/Flexibilität bei der Installation (Rauchgasabzugs und kanalisierbaren von Warmluft)

**** Canalizzazione 2 motori indipendenti**
Duction with 2 independ. motors
Conduits d'aération avec 2 moteurs indépendants
Kanalisierung mit 2 unabhängigen Luftgebläsen

12/
14 kW



Atena Plus 12



Atena Plus 14

Scopri le **caratteristiche del prodotto** e il tuo risparmio con il **conto termico**

Atena Plus 12/14



- Doppia canalizzazione posteriore o superiore con gestione indipendente
- Wi-Fi e bluetooth integrati per il controllo da remoto
- Uscita fumi posteriore, superiore in opzione

- Dual rear or top ducting managed independently
- Built-in Wi-Fi and Bluetooth for remote control
- Back exhaust, upper as option

- Double canalisation postérieure ou supérieure avec gestion indépendante
- Wi-Fi et Bluetooth intégrés pour le contrôle à distance
- Sortie de fumée postérieure, supérieure en option

- Doppelte Luftkanalisierung mit unabhängiger Steuerung hinten oder oben
- Mit integriertem WLAN und Bluetooth zur Fernsteuerung
- Rauchabzug hinten, oben als Option

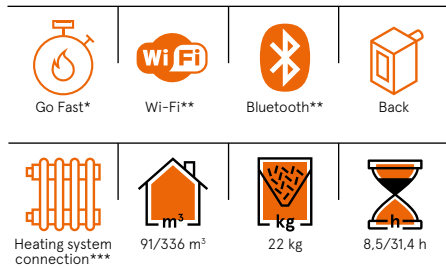

*** Candeletta di tipo ceramico che garantisce un'accensione più rapida del pellet**
Glow plug that guarantees faster pellet ignition
Bougie de préchauffage de type céramique qui garantit un allumage plus rapide du pellet
Keramischen Zündkerze stand, die eine schnellere Zündung der Pellets

**** Gestione tramite Wi-Fi e Bluetooth integrati**
Control through integrated Wi-Fi and Bluetooth
Gestion via Wi-Fi et Bluetooth intégrés
Verwaltung über WLAN und integriertes Bluetooth

***** Colleg. all'impianto di riscaldamento**
Connection to the heating system/Raccordement avec système de chauffage/Anschluss zu Heizungssystem

11,8 kW



Scopri le caratteristiche del prodotto e il tuo risparmio con il conto termico

- Simple and neat design
- Optimised heat and optimal distribution
- Suitable for small homes

- Design simple et soigné
- Optimisation de la chaleur et distribution maximale
- Indiqué pour les petits logements

- Einfaches und gepflegtes Design
- Optimierung der Wärme und maximale Verteilung
- Für kleine Wohnungen geeignet



Idro Prince 12

- Design semplice e curato
- Ottimizzazione del calore e massima distribuzione
- Adatta per piccole abitazioni





*** Sistema di pulizia automatica del braciere**
Innovative automatic brazier cleaning system
Système innovant de nettoyage automatique du brasero / Innovative automatische Brennschalenreinigungssystem-

faster pellet ignition
Bougie de préchauffage de type céramique qui garantit un allumage plus rapide du pellet
Keramischen Zündkerze stand, die eine schnellere Zündung der Pellets

17,7/
24,2 kW

**** Candeletta di tipo ceramico che garantisce un'accensione più rapida del pellet**
Glow plug that guarantees

***** Colleg. all'impianto di riscaldamento**
Connection to the heating system/Raccordement avec système de chauffage/Anschluss zu Heizungssystem

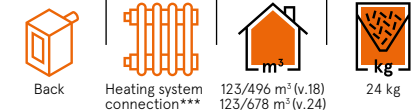

River idrotech 18



River idrotech 24



River idrotech 24 H₂O

Scopri le caratteristiche del prodotto e il tuo risparmio con il conto termico

River Idrotech 18/24/24 H₂O

- Versione con braciere autopulente
- Stufa dalle alte prestazioni per il riscaldamento centralizzato della casa
- 5 stelle AriaPulita™
- Candeletta ceramica

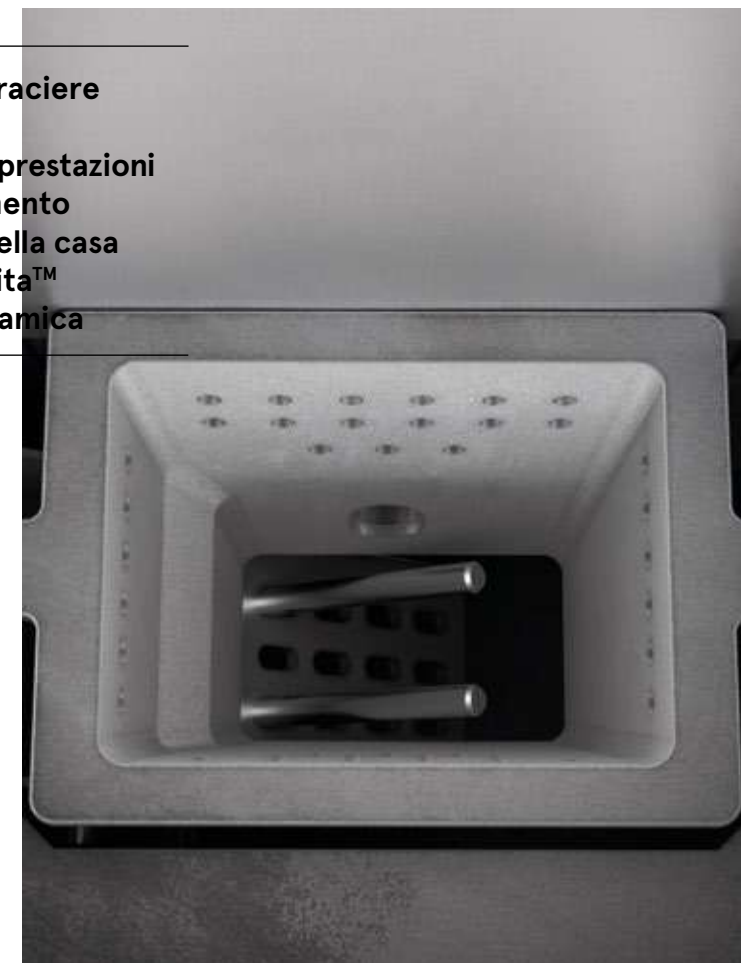

For H₂O version

- Version with self-cleaning brazier
- High-performance stove for centralised heating of the home
- Ceramic plug
- Version avec brasero autonettoyant
- Poêle aux performances élevées pour le chauffage centralisé des habitations
- Préchauffage de type céramique
- Version mit selbstreinigender Brennschale
- Leistungsstarker Ofen für die Zentralheizung des Hauses
- Keramischen Zündkerze

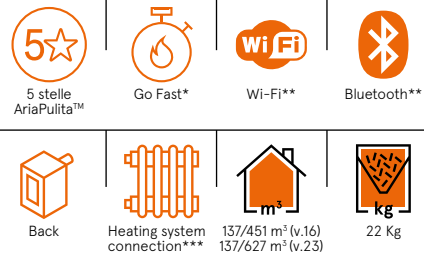

*** Candeletta di tipo ceramico che garantisce un'accensione più rapida del pellet**
Glow plug that guarantees faster pellet ignition
Bougie de préchauffage de type céramique qui garantit un allumage plus rapide du pellet
Keramischen Zündkerze stand, die eine schnellere Zündung der Pellets

**** Gestione tramite Wi-Fi e Bluetooth integrati**
Control through integrated Wi-Fi and Bluetooth
Gestion via Wi-Fi et Bluetooth intégrés
Verwaltung über WLAN und integriertes Bluetooth

***** Colleg. all'impianto di riscaldamento**
Connection to the heating system/Raccordement avec système de chauffage/Anschluss zu Heizungssystem

16,1/
22,4 kW



River Idro 16



River Idro 23

Scopri le caratteristiche del prodotto e il tuo risparmio con il conto termico



River Idro 16/23











- Linee morbide dal sapore classico contemporaneo
- Stufa idro ventilata
- Rivestimenti in metallo o in pregiata ceramica



- Soft lines with a classic contemporary feel
- Ventilated hydro stove
- Metal cladding or high-quality ceramics

- Des lignes souples avec une touche classique contemporaine
- Poêle hydro ventilé
- Habillages en métal ou céramique précieuse

- Weiche Linien mit klassischem, modernem Look
- Belüfteter wasserführender Ofen
- Verkleidungen aus Metall oder aus wertvoller Keramik

 Go Fast*	 Wi-Fi**	 Bluetooth**	 Up
 Collegam. imp.	 165/513 m ² (v.16)	 10,3/33,3 h (16)	 40 kg
 riscaldamento**	 165/704 m ² (v.24)	 7,3/33,3 h (24)	

* Candeletta di tipo ceramico che garantisce un'accensione più rapida del pellet
Glow plug that guarantees faster pellet ignition
Bougie de préchauffage de type céramique qui garantit un allumage plus rapide du pellet
Keramischen Zündkerze stand, die eine schnellere Zündung der Pellets

** Gestione tramite Wi-Fi e Bluetooth integrati
Control through integrated Wi-Fi and Bluetooth
Gestion via Wi-Fi et Bluetooth intégrés
Verwaltung über WLAN und integriertes Bluetooth

*** Kit completo Idro riscaldamento + acqua sanitaria/Complete kit heating + domestic water
Kit complet Idro chauffage + eau sanitaire
Komplett-Set Hydro Heizung + Brauchwasser

18/
24,7 kW



Saturno 16



Saturno 24

Scopri le caratteristiche del prodotto e il tuo risparmio con il conto termico

Saturno 16/24

- Inserto dal design minimale, con ampia visione del fuoco
- Disponibile nelle potenze di 16 e 24 kW con ventilazione frontale
- Wi-Fi e Bluetooth integrati



- Insert with a minimalist design, with a large view of the fire
- Available with outputs of 16 and 24 kW with front ventilation
- Built-in Wi-Fi and Bluetooth

- Un insert au design minimaliste, avec une grande vue du feu
- Disponible dans une puissance de 16 et 24 kW avec ventilation frontale
- Wi-Fi et Bluetooth intégrés

- Kamineinsatz mit minimalistischem Design mit guter Sicht auf das Feuer
- Mit 16 und 24 kW Leistung und Frontgebläse erhältlich
- Integrierte WLAN und Bluetooth

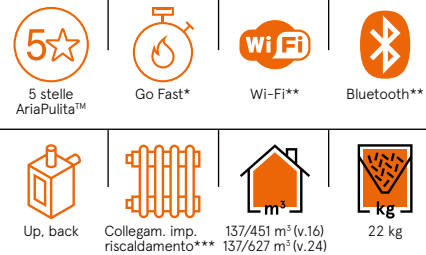

*** Candeletta di tipo ceramico che garantisce un'accensione più rapida del pellet**
Glow plug that guarantees faster pellet ignition
Bougie de préchauffage de type céramique qui garantit un allumage plus rapide du pellet
Keramischen Zündkerze stand, die eine schnellere Zündung der Pellets

**** Gestione tramite Wi-Fi e Bluetooth integrati**
Control through integrated Wi-Fi and Bluetooth
Gestion via Wi-Fi et Bluetooth intégrés
Verwaltung über WLAN und integriertes Bluetooth

***** Collegamento all'impianto di riscaldamento.**
Connection to the heating system/Raccordement avec système de chauffage/Anschluss zu Heizungssystem

16,1/
22,4 kW



Maya Idro 16



Maya Idro 24

Scopri le caratteristiche del prodotto e il tuo risparmio con il conto termico

Maya Idro 16/24

- Disponibile nelle potenze di 16 e 24 kW
- Ventilata e pensata per gli spazi ristretti
- Rivestimento in metallo in vari colori

- Available with outputs of 16 and 24 kW
- Ventilated and designed for confined spaces
- Metal cladding in various colours
- Disponible dans les puissances 16 et 24 kW
- Ventilé et conçu pour les petits espaces
- Habillages en métal de différentes couleurs
- Mit 16 und 24 kW Leistung erhältlich
- Belüftet und für enge Platzverhältnisse gedacht
- Metallverkleidung in mehreren Farben



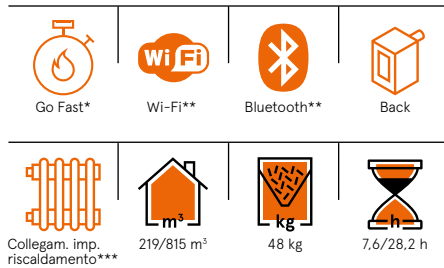

*** Candeletta di tipo ceramico che garantisce un'accensione più rapida del pellet**
Glow plug that guarantees faster pellet ignition
Bougie de préchauffage de type céramique qui garantit un allumage plus rapide du pellet
Keramischen Zündkerze stand, die eine schnellere Zündung der Pellets

**** Gestione tramite Wi-Fi e Bluetooth integrati**
Control through integrated Wi-Fi and Bluetooth
Gestion via Wi-Fi et Bluetooth intégrés
Verwaltung über WLAN und integriertes Bluetooth

***** Collegamento all'impianto di riscaldamento**
Connection to the heating system/Raccordement avec système de chauffage/Anschluss zu Heizungssystem

28,6 kW



Scopri le caratteristiche del prodotto e il tuo risparmio con il conto termico

- La più potente tra le Hydro
- Serbatoio 48 kg
- Wi-Fi esterno incluso



Idro Prince 30



- The most powerful of the Hydro stoves
- 48 kg hopper
- External Wi-Fi included
- Le plus puissant parmi les Hydro
- Réservoir de 48 kg
- Wi-Fi externe inclus
- Der leistungsstärkste unter den wasserführenden Öfen
- 48 kg Behälter
- Externes WLAN inbegriffen



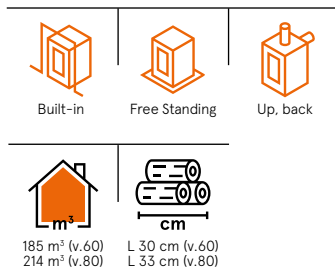

6,5/
7,5 kW



Smart 60



Smart 80

Scopri le
caratteristiche
del prodotto
e il tuo risparmio
con il conto
termico

Smart 60/80

- **Porte in ghisa, eleganti maniglie e corrimano in acciaio**
- **Da incasso e a libera installazione**
- **Con piedini estetici o zoccolo in acciaio**



- Cast iron doors, elegant handles and steel handrail
- Recessed or free installation
- With aesthetic feet or steel basement
- Portes en fonte, poignées élégantes et mains courantes en acier
- Encastrable ou en pose libre
- Avec pieds décoratifs ou socle en acier
- Türen aus Gusseisen, elegante Griffe und Handlauf aus Stahl
- Zum Einbau oder freistehend
- Mit Zierfüßen oder Stahlsockel



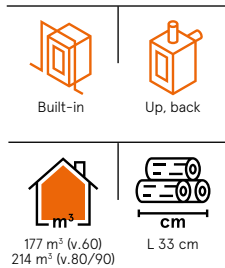

6,2/
7,5 kW



Kook 60



Kook 80



Kook 90

Scopri le
caratteristiche
del prodotto

- Da incasso
- Camera di combustione con interno in refrattario
- Ampio vetro per vista sul forno



Kook 60/80/90

- Built-in
- Combustion chamber with refractory stone interior
- Large glass window offering a view on the oven
- Encastrable
- Chambre de combustion avec intérieur en matériau réfractaire
- Grande vitre pour une meilleure vue du four
- Zum Einbau
- Brennkammer mit feuerbeständigem Innenraum
- Große Glasscheibe für den Blick aufs Feuer



Technical features

Pellet Air

- P.82 **Spirit 5**
- P.83 **Spirit 5 Up**
- P.83 **Sound 5 Ps**
- P.84 **Sound 7 Ps**
- P.84 **Sound 5 Up-Twin**
- P.85 **Sound 7 Up-Twin**
- P.85 **Hublot 6 Up-Twin**
- P.86 **Magritte 6**
- P.86 **Grace 7**
- P.87 **Grace 7 Up**
- P.87 **Cristal 7**
- P.88 **Cristal 7 Up**
- P.88 **Sweet 7**
- P.89 **Perla 7**
- P.89 **Cristal 9**
- P.90 **Quasimodo 9**
- P.90 **Box/Up-Twin**
- P.90 **Zefiro 9**
- P.91 **Frame 9**
- P.91 **Frame 9 Up-Twin**
- P.92 **Shell 9 Ps**
- P.92 **Shell 9 Up-Twin**
- P.93 **Prince 11**
- P.93 **Kobe 11**
- P.94 **Fenice 11**

Pellet Air Plus

- P.95 **Cristal Plus 9**
- P.96 **Icon Plus 9**
- P.96 **Luce Plus 9**
- P.97 **Elle Plus 9**
- P.97 **Tile Plus 10**
- P.98 **Wall Plus 10**
- P.98 **Prince Plus 11**
- P.99 **Kobe Plus 11**
- P.99 **Fenice Plus 11**
- P.100 **Mithos Plus 12 Ps**
- P.100 **Mithos Plus 14 Ps**
- P.101 **Mithos Plus 12**
- P.101 **Up-Twin**
- P.101 **Mithos Plus 14**
- P.101 **Up-Twin**
- P.102 **Atena Plus 12**
- P.102 **Atena Plus 14**

Pellet Hydro

- P.103 **Idro Prince 12**
- P.104 **River idrotech 18**
- P.104 **River idrotech**
- P.104 **24/24 H₂O**
- P.105 **River Idro 16**
- P.105 **River Idro 23**
- P.106 **Saturno 16**
- P.106 **Saturno 24**
- P.107 **Maya Idro 16**
- P.107 **Maya Idro 24**
- P.108 **Idro Prince 30**

Wood

- P.109 **Smart 60**
- P.110 **Smart 80**
- P.110 **Kook 60**
- P.111 **Kook 80**
- P.111 **Kook 90**

Pellet Air

Spirit 5 ● 5,2 kW P. 14

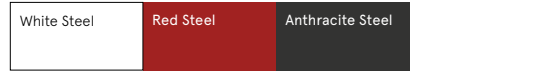
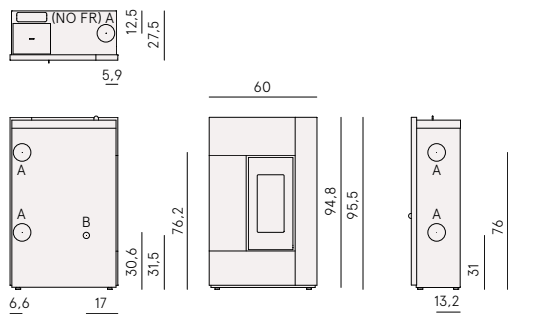

5.2 kW	5.8 kW	71 m³ 148 m³	12 kg	9.7 h 21.1 h	0.57 kg/h 1.24 kg/h	89.5 %
91.5 %	2.5 kW	55 kg	Pellet ø 6 mm	ø 80 mm	ø 60 mm	

European standards Art. 15A B-VG 2015 BImSchV 2015 Regensburg
München Stuttgart Aachen EN 14785:2006
CE Certificate model name: SPIRIT3 5kW



Spirit 5 Up ● 5,2 kW P. 14

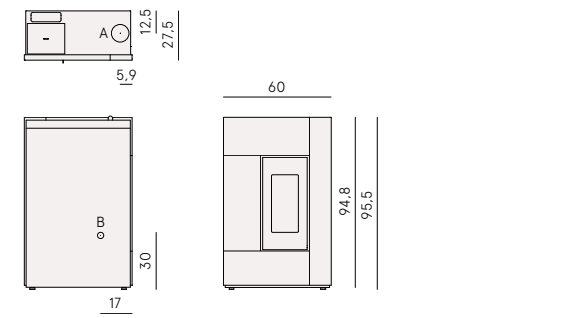

5.2 kW	5.8 kW	71 m³ 148 m³	12 kg	9.7 h 21.1 h	0.57 kg/h 1.24 kg/h	89.5 %
91.5 %	2.5 kW	55 kg	Pellet ø 6 mm	ø 80 mm	ø 60 mm	

European standards Art. 15A B-VG 2015 BImSchV 2015 Regensburg
München Stuttgart Aachen EN 14785:2006
CE Certificate model name: SPIRIT3 5kW



Sound 5 Ps ● 5,5 kW P. 16

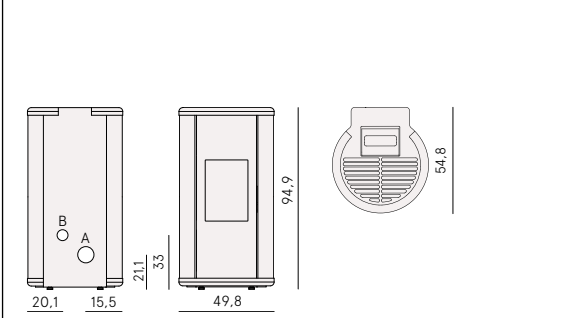

5.5 kW	6.1 kW	71 m³ 157 m³	11 kg	8.5 h 18 h	0.6 kg/h 1.3 kg/h	90 %
91 %	2.5 kW	76 kg	Pellet ø 6 mm	ø 80 mm	ø 60 mm	

European standards BImSchV 2015 Regensburg München
Stuttgart Aachen EN 14785:2006
CE Certificate model name: SOUND 5 PS



Stufe ad aria ventilata dotate di camera stagna, con potenze da 5 a 11 kW

Stove with ventilated air and sealed chamber, with outputs from 5 to 11 kW

Poêles à air ventilé avec chambre étanche, puissance de 5 à 11 kW

Luftführende belüftete Öfen mit abgedichteter Kammer und Leistung zwischen 5 und 11 kW

Sound 7 Ps ● 7 kW

P. 16



Scopri le **caratteristiche** e il risparmio del **conto termico**

A+

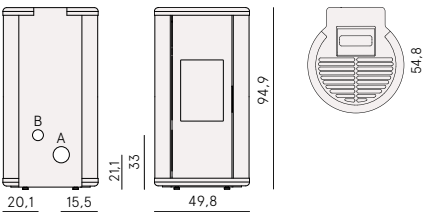

Anthracite Steel

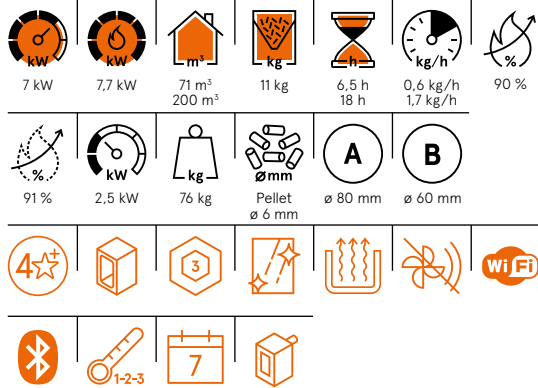

European standards
BlmSchV 2015
Regensburg
München

Stuttgart
Aachen
EN 14785:2006

CE
Certificate model name:
SOUND 7 PS



Sound 5 Up-Twin ● 5,5 kW

P. 16



Scopri le **caratteristiche** e il risparmio del **conto termico**

A+

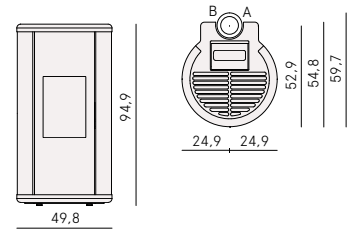

White Steel Titanium Steel Anthracite Steel

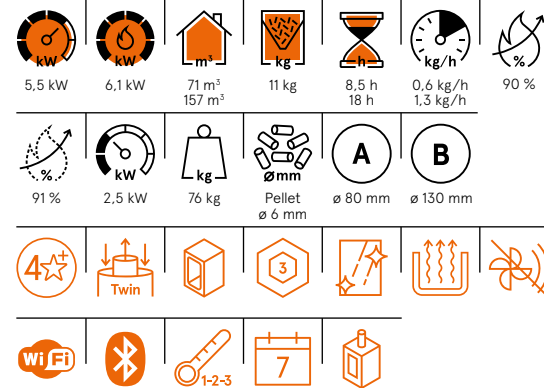

European standards
Art. 15A B-VG 2015
BlmSchV 2015
Regensburg

München
Stuttgart
Aachen
EN 14785:2006

CE
Certificate model name:
SOUND3 5 UP



Sound 7 Up-Twin ● 7 kW

P. 16



Scopri le **caratteristiche** e il risparmio del **conto termico**

A+

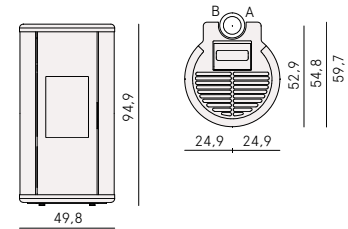

White Steel Titanium Steel Anthracite Steel

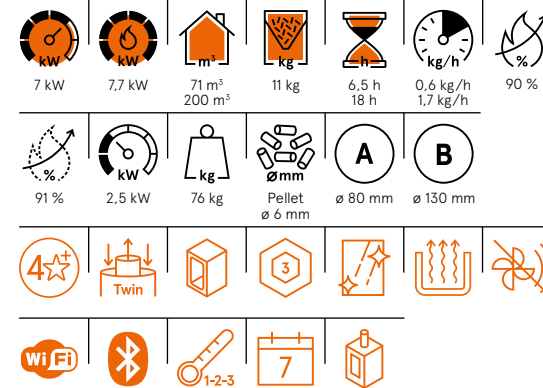

European standards
Art. 15A B-VG 2015
BlmSchV 2015
Regensburg

München
Stuttgart
Aachen
EN 14785:2006

CE
Certificate model name:
SOUND3 7 UP



Hublot 6 Up-Twin ● 6 kW

P. 18



Scopri le **caratteristiche** e il risparmio del **conto termico**

A+

New

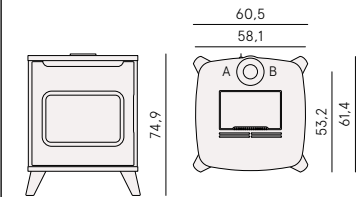

Cast Iron and Black Steel

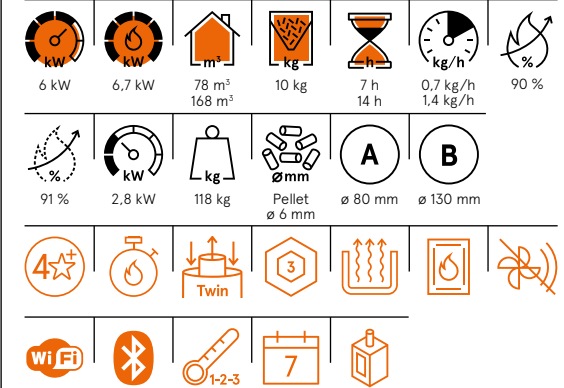

European standards
Art. 15A B-VG 2015
BlmSchV 2015
Regensburg

München
Stuttgart
Aachen
EN 14785:2006

CE
Certificate model name:
HUBLOT 6 UP T1



Magritte 6 ● 6 kW

P. 22



Scopri le **caratteristiche** e il risparmio del **conto termico**

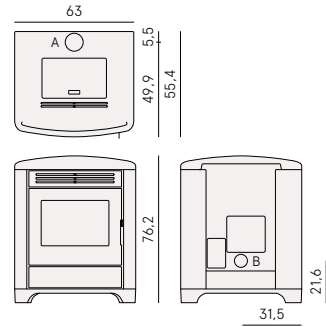

Cast Iron and Black Steel

6 kW	6.7 kW	78 m ³ 168 m ³	10 kg	7 h 14 h	0.7 kg/h 1.4 kg/h	90%
91%	2.8 kW	126 kg	Pellet ø 6 mm	ø 80 mm	ø 60 mm	

European standards Art. 15A B-VG 2015 BImSchV 2015 Regensburg
München Stuttgart Aachen EN 14785:2006
CE Certificate model name: MAGRITTE 6 T1



Grace 7 ● 7 kW

P. 24



Scopri le **caratteristiche** e il risparmio del **conto termico**

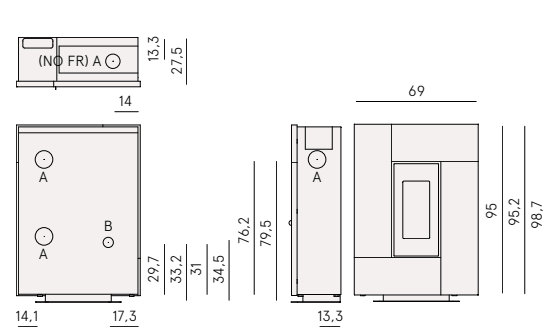

White Steel Red Steel Anthracite Steel
Black Glass Light Bronze Steel Serpentino Stone

7 kW	7.8 kW	77 m ³ 200 m ³	12 kg	7.1 h 19.7 h	0.61 kg/h 1.7 kg/h	89.5%
93%	2.7 kW	63.5 kg 72/80 kg	Pellet ø 6 mm	ø 80 mm	ø 60 mm	

European standards BImSchV 2015 Regensburg München
Stuttgart Aachen Regensburg München EN 14785:2006
CE Certificate model name: GRACE3



Grace 7 Up ● 7 kW

P. 24



Scopri le **caratteristiche** e il risparmio del **conto termico**

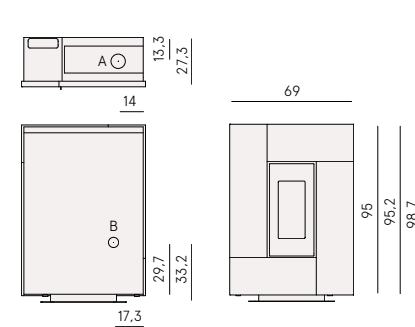

White Steel Red Steel Anthracite Steel
Black Glass Light Bronze Steel Serpentino Stone

7 kW	7.8 kW	77 m ³ 200 m ³	12 kg	7.1 h 19.7 h	0.61 kg/h 1.7 kg/h	89.5%
93%	2.7 kW	63.5 kg 72/80 kg	Pellet ø 6 mm	ø 80 mm	ø 60 mm	

European standards BImSchV 2015 Regensburg München
Stuttgart Aachen Regensburg München EN 14785:2006
CE Certificate model name: GRACE3



Cristal 7 ● 7 kW

P. 26



Scopri le **caratteristiche** e il risparmio del **conto termico**

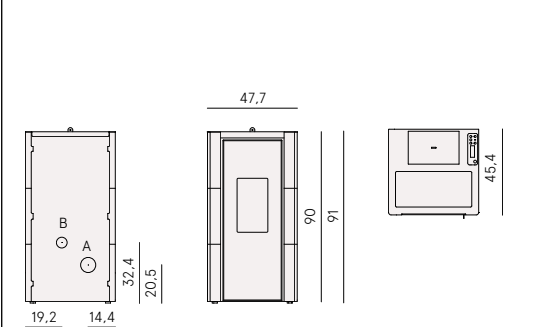

White Steel Red Steel Anthracite Steel

7 kW	7.7 kW	71 m ³ 200 m ³	15 kg	8.8 h 25 h	0.6 kg/h 1.7 kg/h	90%
91%	2.5 kW	56 kg	Pellet ø 6 mm	ø 80 mm	ø 60 mm	

European standards Art. 15A B-VG 2015 BImSchV 2015 Regensburg
München Stuttgart Aachen Regensburg München EN 14785:2006
CE Certificate model name: CRISTAL3 7.0



Cristal 7 Up ● 7 kW

P. 26



Scopri le **caratteristiche** e il risparmio del **conto termico**

A+

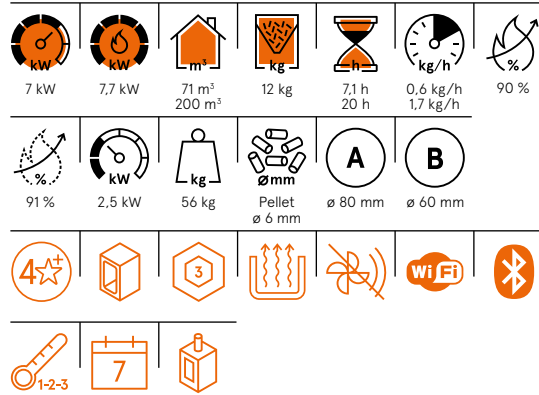
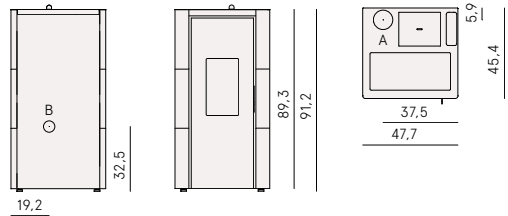

European standards Art. 15A B-VG 2015 BImSchV 2015 Regensburg München Stuttgart Aachen EN 14785:2006 **CE** Certificate model name: CRISTAL3 7.0 UP



Sweet 7 ● 7 kW

P. 28



Scopri le **caratteristiche** e il risparmio del **conto termico**

A+

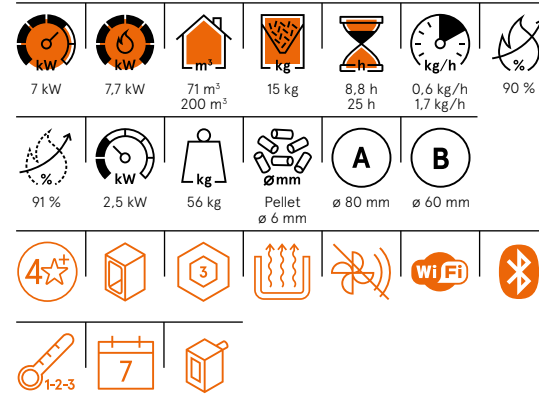
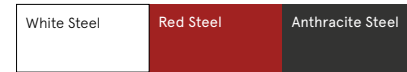
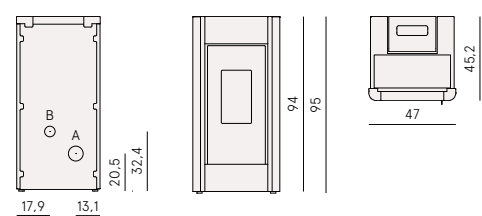

European standards Art. 15A B-VG 2015 BImSchV 2015 Regensburg München Stuttgart Aachen EN 14785:2006 **CE** Certificate model name: SWEET3 7.0



Perla 7 ● 7 kW

P. 30



Scopri le **caratteristiche** e il risparmio del **conto termico**

A+

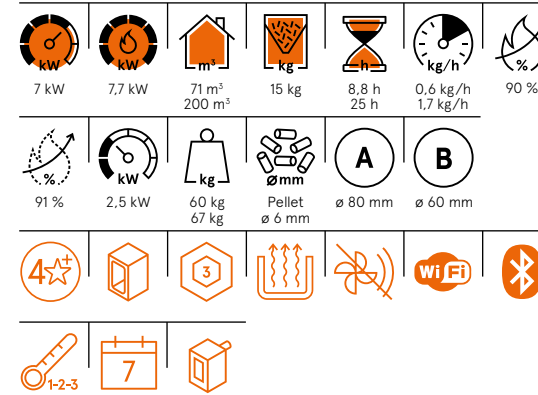
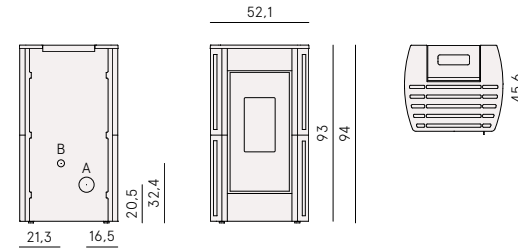

European standards Art. 15A B-VG 2015 BImSchV 2015 Regensburg München Stuttgart Aachen EN 14785:2006 **CE** Certificate model name: PERLA3 7.0



Cristal 9 ● 8,5 kW

P. 38



Scopri le **caratteristiche** e il risparmio del **conto termico**

A+

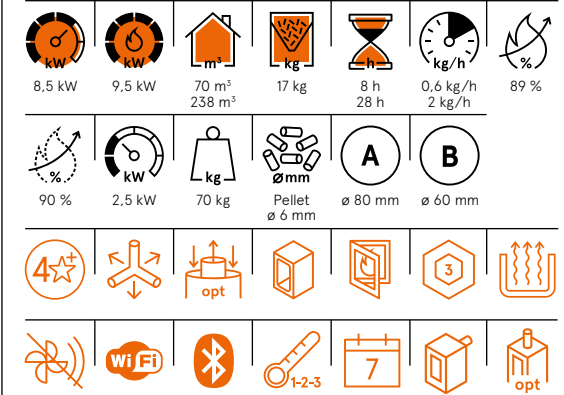
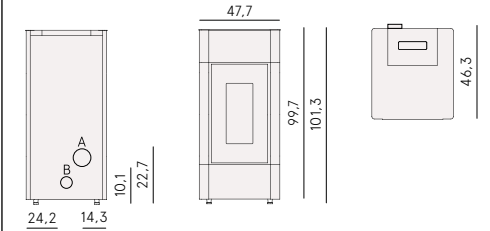

European standards Art. 15A B-VG 2015 BImSchV 2015 Regensburg München Stuttgart Aachen EN 14785:2006 **CE** Certificate model name: CRISTAL 9 T1



Quasimodo 9 Box/Up-Twin

● 9,3 kW
P. 42



Scopri le **caratteristiche** e il risparmio del **conto termico**

A+

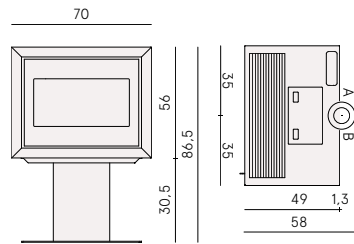

Black Steel

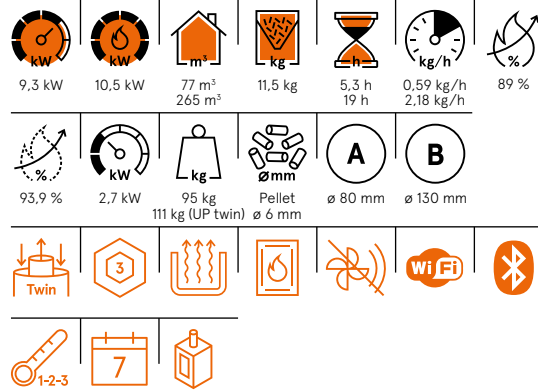

European standards
Art. 15A B-VG 2015
BImSchV 2015
Regensburg

München
Stuttgart
Aachen
EN 14785:2006

CE
Certificate model name:
QUASIMODO3 UP



Zefiro 9 ● 9,3 kW

P. 44



Scopri le **caratteristiche** e il risparmio del **conto termico**

A+

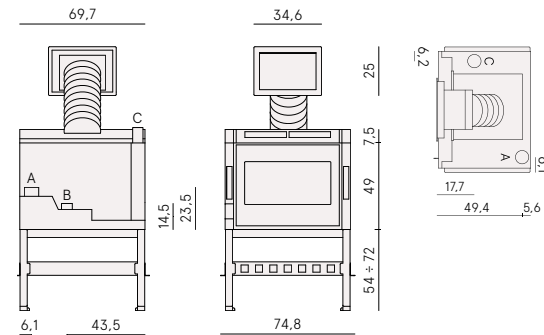

Black Glass

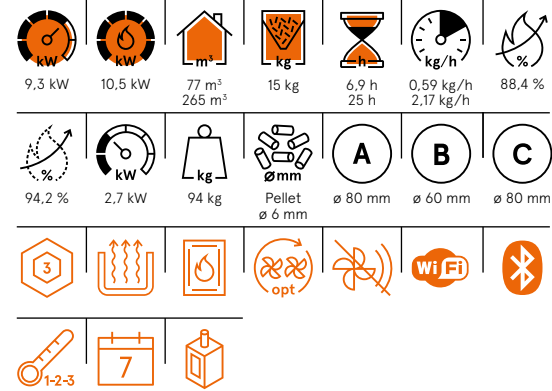

European standards
Art. 15A B-VG 2015
BImSchV 2015
Regensburg

München
Stuttgart
Aachen
EN 14785:2006

CE
Certificate model name:
ZEFIRO3 9kW



Frame 9 ● 9,3 kW

P. 46



Scopri le **caratteristiche** e il risparmio del **conto termico**

A+

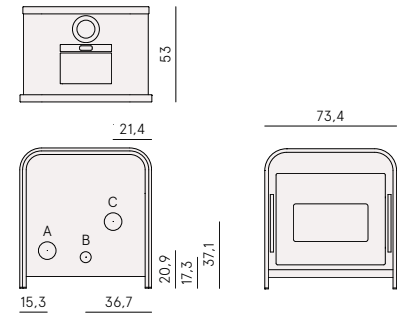

Light Bronze Steel

Black Steel

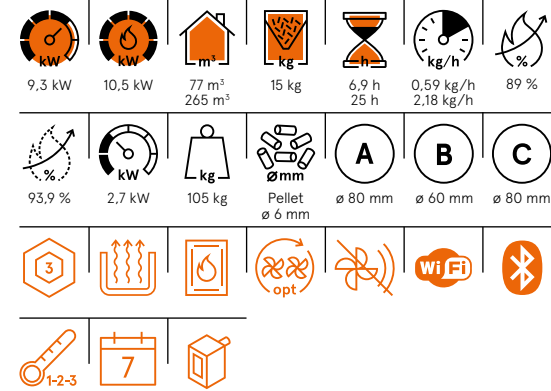

European standards
Art. 15A B-VG 2015
BImSchV 2015
Regensburg

München
Stuttgart
Aachen
EN 14785:2006

CE
Certificate model name:
FRAME3 9 kW



Frame 9 Up-Twin ● 9,3 kW

P. 46



Scopri le **caratteristiche** e il risparmio del **conto termico**

A+

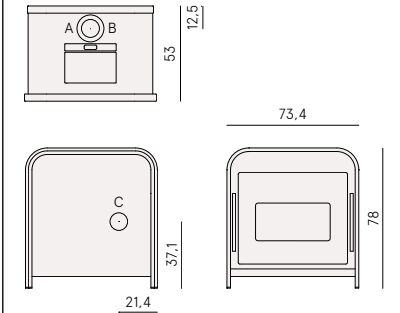

Light Bronze Steel

Black Steel

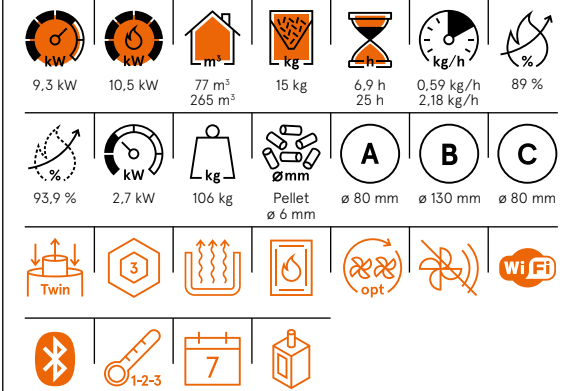

European standards
Art. 15A B-VG 2015
BImSchV 2015
Regensburg

München
Stuttgart
Aachen
EN 14785:2006

CE
Certificate model name:
FRAME3 UP 9 kW



Shell 9 Ps ● 9,1 kW

P. 48



Scopri le **caratteristiche** e il risparmio del **conto termico**

A+

Shell 9 Up-Twin ● 9,1 kW

P. 48



Scopri le **caratteristiche** e il risparmio del **conto termico**

A+

Prince 11 ● 10,5 kW

P. 54



Scopri le **caratteristiche** e il risparmio del **conto termico**

A+

Kobe 11 ● 10,5 kW

P. 56



Scopri le **caratteristiche** e il risparmio del **conto termico**

A+

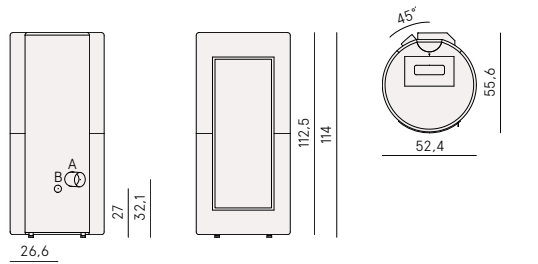

Titanium Steel Anthracite Steel

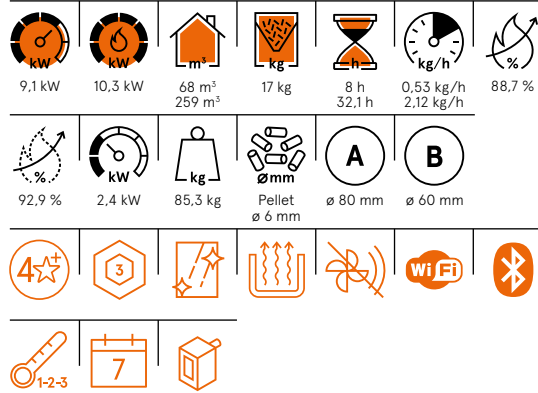

European standards Art. 15A B-VG 2015 BImSchV 2015 Regensburg München Stuttgart Aachen EN 14785:2006 **CE** Certificate model name: SHELL 9 PS

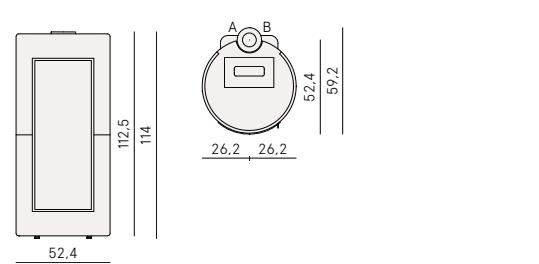

White Steel Titanium Steel Anthracite Steel

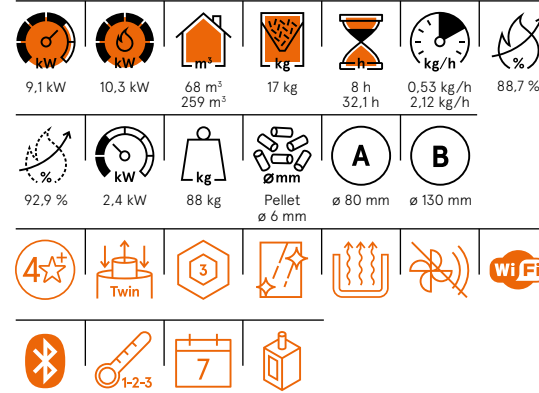

European standards Art. 15A B-VG 2015 BImSchV 2015 Regensburg München Stuttgart Aachen EN 14785:2006 **CE** Certificate model name: SHELL 3 UP

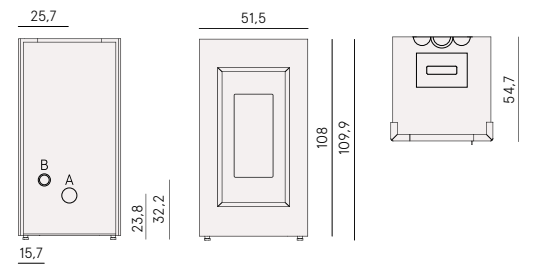

White Steel Light Bronze Steel Titanium Steel Red Steel Anthracite Steel

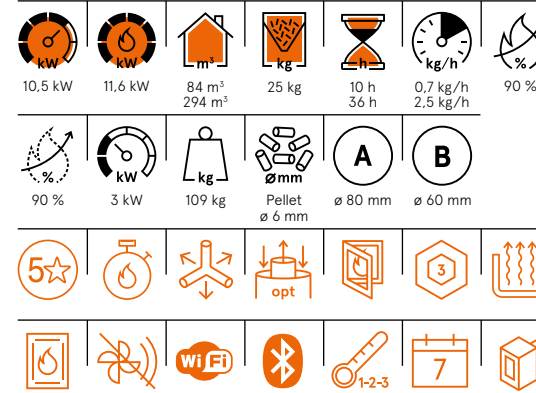

European standards Art. 15A B-VG 2015 BImSchV 2015 Regensburg München Stuttgart Aachen EN 14785:2006 **CE** Certificate model name: PRINCE 11 TI

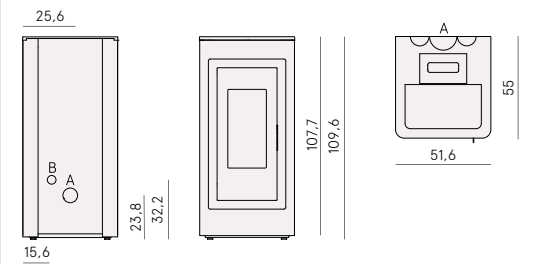

White Steel Light Bronze Steel Titanium Steel Red Steel Anthracite Steel

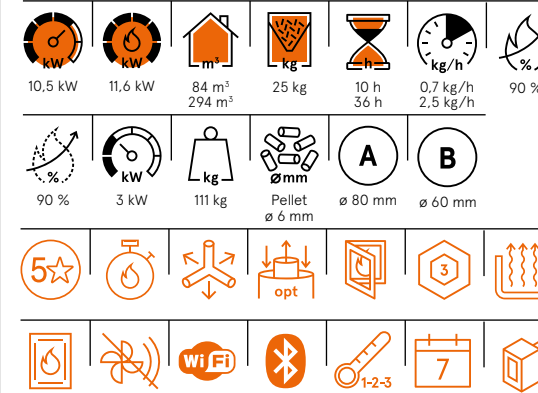

European standards Art. 15A B-VG 2015 BImSchV 2015 Regensburg München Stuttgart Aachen EN 14785:2006 **CE** Certificate model name: KOBE 11 TI



Fenice 11 ● 10,5 kW

P. 58



Scopri le caratteristiche e il risparmio del conto termico

A+

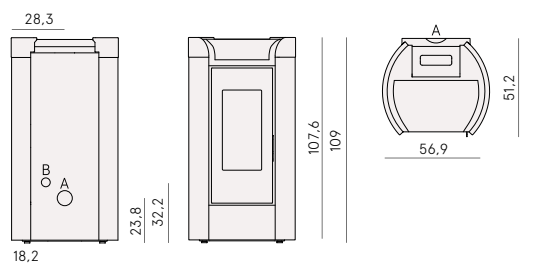

White - gold	Anthracite - titanium	Titanium - anthracite
--------------	-----------------------	-----------------------

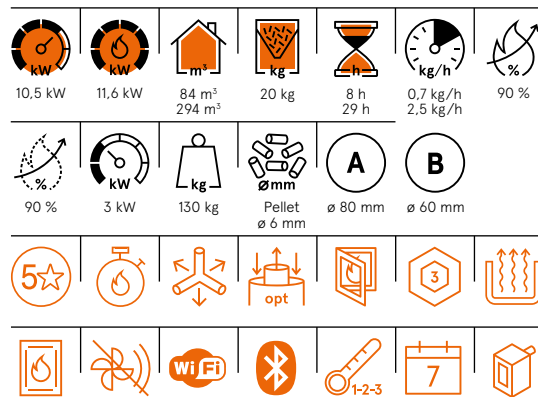

European standards Art. 15A B-VG 2015 BImSchV 2015 Regensburg
München Stuttgart Aachen EN 14785:2006
CE Certificate model name: FENICE 11 T1



Pellet Air Plus

Stufe canalizzabili per riscaldare più ambienti della casa in modo omogeneo e in economia, con potenze da 9 a 14 kW

Ductable stoves to heat several rooms in the house evenly and inexpensively, with outputs from 9 to 14 kW

Poêles canalisables pour chauffer plusieurs pièces d'une habitation de façon homogène et à petit prix, puissance de 9 à 14 kW

Kanalisiertbare Öfen zum gleichmäßigen und wirtschaftlichen Beheizen von mehreren Räumen, mit Leistungen zwischen 9 und 14 kW

Cristal Plus 9 ● 8,5 kW

P. 38



Scopri le caratteristiche e il risparmio del conto termico

A+

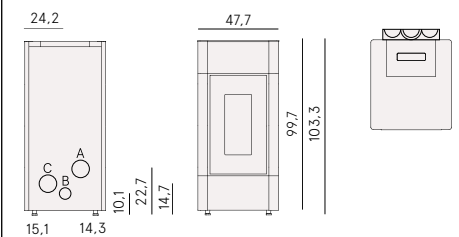

White Steel	Red Steel	Anthracite Steel
-------------	-----------	------------------

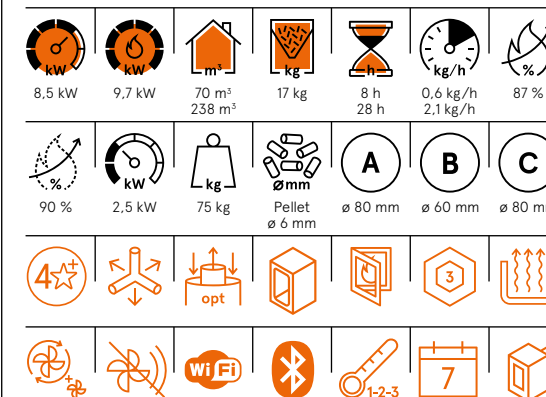

European standards Art. 15A B-VG 2015 BImSchV 2015 Regensburg
München Stuttgart Aachen EN 14785:2006
CE Certificate model name: CRISTAL PLUS 9 T1



Icon Plus 9 ● 8,5 kW

P. 40



Scopri le **caratteristiche** e il risparmio del **conto termico**

A+

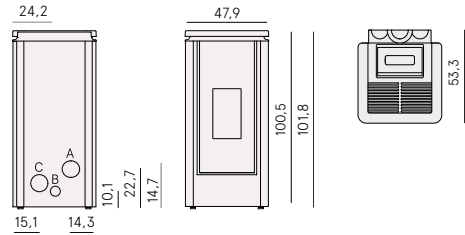

White Steel	Light Bronze Steel	Titanium Steel
Red Steel	Anthracite Steel	

8.5 kW	9.7 kW	70 m ³ 238 m ³	17 kg	8 h 28 h	0,6 kg/h 2,1 kg/h	87 %
90 %	2.5 kW	87 kg	Pellet ø 6 mm	A ø 80 mm	B ø 60 mm	C ø 80 mm

European standards Art. 15A B-VG 2015 BImSchV 2015 Regensburg München Stuttgart Aachen EN 14785:2006 **CE** Certificate model name: ICON PLUS 9 T1



Luce Plus 9 ● 8,5 kW

P. 32



Scopri le **caratteristiche** e il risparmio del **conto termico**

A+

New

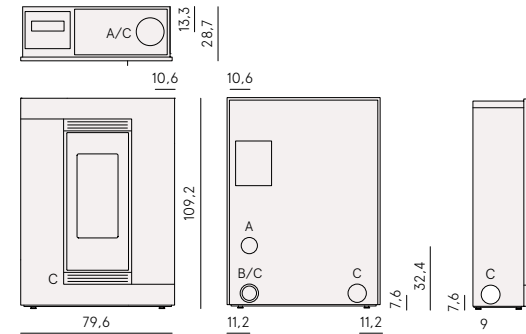

White Steel	Light Bronze Steel	Titanium Steel	Anthracite Steel
-------------	--------------------	----------------	------------------

8.5 kW	9.9 kW	92 m ³ 238 m ³	15 kg	8 h 21 h	0,7 kg/h 2 kg/h	89 %
89 %	3.3 kW	95 kg	Pellet ø 6 mm	A ø 80 mm	B ø 60 mm	C ø 80 mm

European standards Art. 15A B-VG 2015 BImSchV 2015 Regensburg München Stuttgart Aachen EN 14785:2006 **CE** Certificate model name: LUCE PLUS 9 T2



Elle Plus 9 ● 8,5 kW

P. 34



Scopri le **caratteristiche** e il risparmio del **conto termico**

A+

New

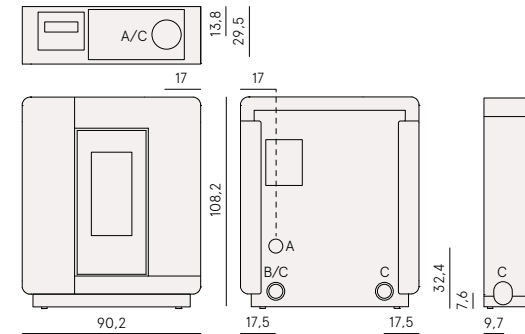

Light Bronze Steel	Ossido Bruno Stone	Nero Greco Stone
Titanium Steel	Verre Noir	

8.5 kW	9.9 kW	92 m ³ 238 m ³	15 kg	8 h 21 h	0,7 kg/h 2 kg/h	89 %
89 %	3.3 kW	126 kg	Pellet ø 6 mm	A ø 80 mm	B ø 60 mm	C ø 80 mm

European standards Art. 15A B-VG 2015 BImSchV 2015 Regensburg München Stuttgart Aachen EN 14785:2006 **CE** Certificate model name: ELLE PLUS 9 T2



Tile Plus 10 ● 10 kW

P. 50



Scopri le **caratteristiche** e il risparmio del **conto termico**

A+

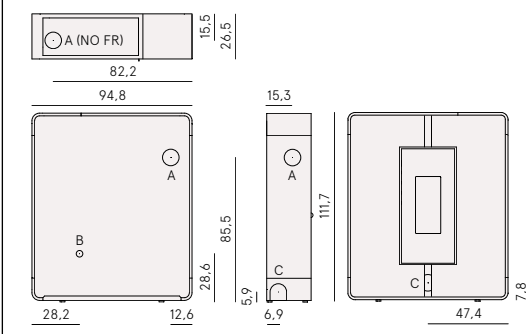

White Steel	Light Bronze Steel	Titanium Steel
Red Steel	Anthracite Steel	

10 kW	11 kW	86 m ³ 285 m ³	18 kg	8 h 27.3 h	0,66 kg/h 2,24 kg/h	91 %
94.5 %	3 kW	130 kg	Pellet ø 6 mm	A ø 80 mm	B ø 60 mm	C ø 80 mm

European standards Art. 15A B-VG 2015 BImSchV 2015 Regensburg München Stuttgart Aachen EN 14785:2006 **CE** Certificate model name: TILE* PLUS



Wall Plus 10 ● 10 kW

P. 52



Scopri le **caratteristiche** e il risparmio del **conto termico**

A+

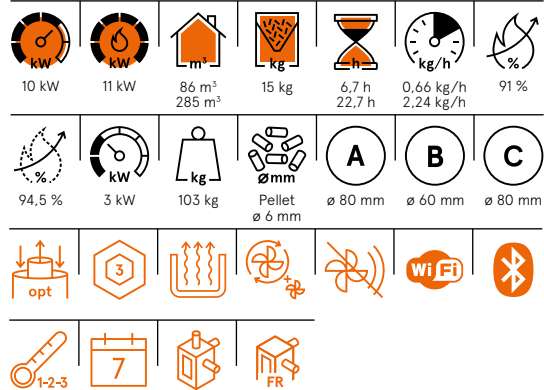
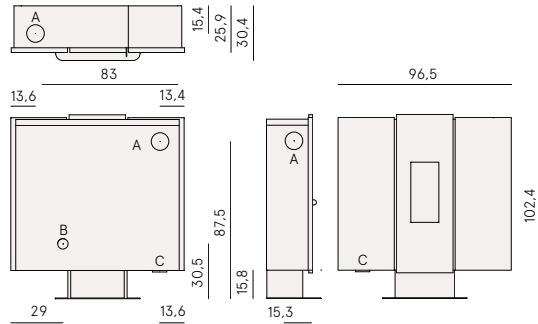

European standards Art. 15A B-VG 2015 BImSchV 2015 Regensburg München Stuttgart Aachen EN 14785:2006 **CE** Certificate model name: WALL3 PLUS



Prince Plus 11 ● 10,5 kW

P. 54



Scopri le **caratteristiche** e il risparmio del **conto termico**

A+

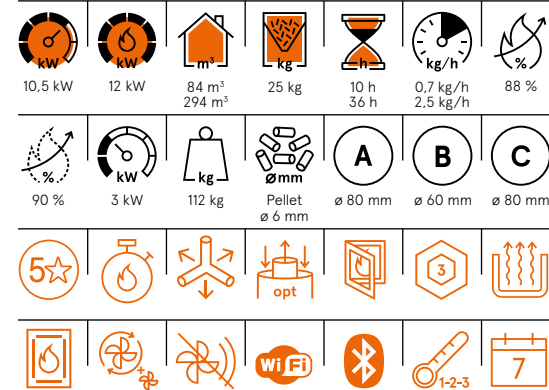
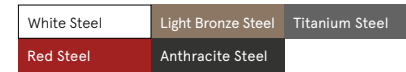
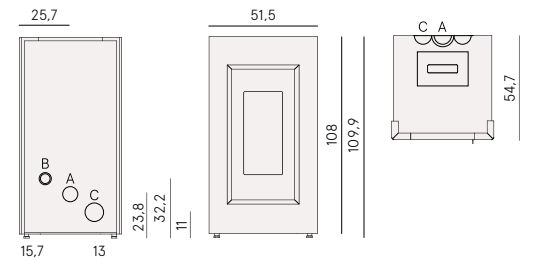

European standards Art. 15A B-VG 2015 BImSchV 2015 Regensburg München Stuttgart Aachen EN 14785:2006 **CE** Certificate model name: PRINCE PLUS 11 T1



Kobe Plus 11 ● 10,5 kW

P. 56



Scopri le **caratteristiche** e il risparmio del **conto termico**

A+

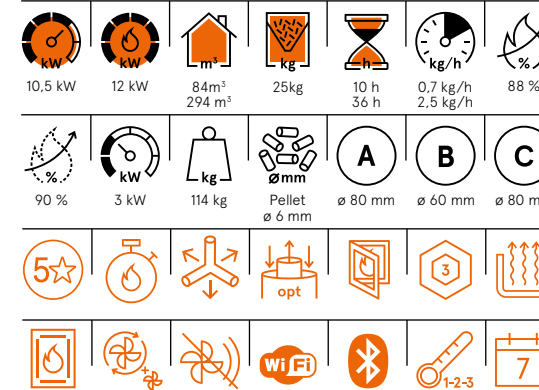
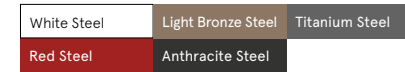
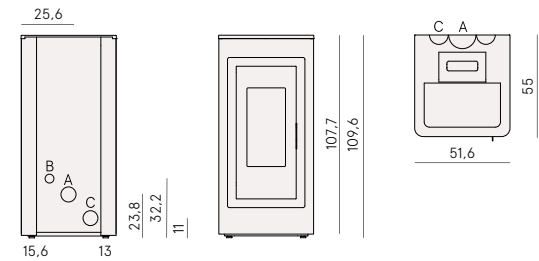

European standards Art. 15A B-VG 2015 BImSchV 2015 Regensburg München Stuttgart Aachen EN 14785:2006 **CE** Certificate model name: KOBE PLUS 11 T1



Fenice Plus 11 ● 10,5 kW

P. 58



Scopri le **caratteristiche** e il risparmio del **conto termico**

A+

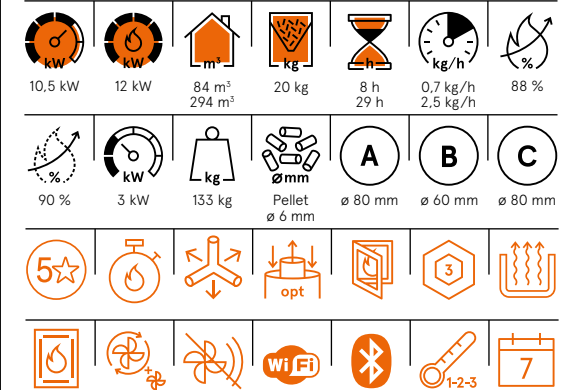
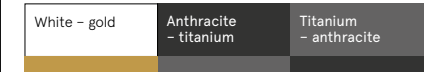
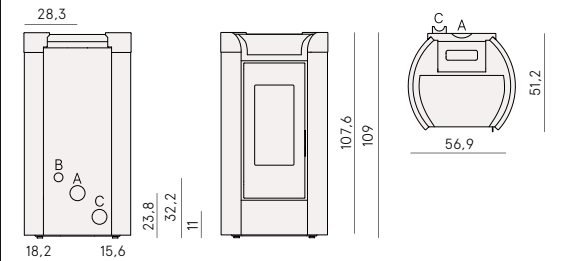

European standards Art. 15A B-VG 2015 BImSchV 2015 Regensburg München Stuttgart Aachen EN 14785:2006 **CE** Certificate model name: FENICE PLUS 11 T1



Mithos Plus 12 Ps ● 12 kW

P. 60



Scopri le **caratteristiche** e il risparmio del **conto termico**

A+

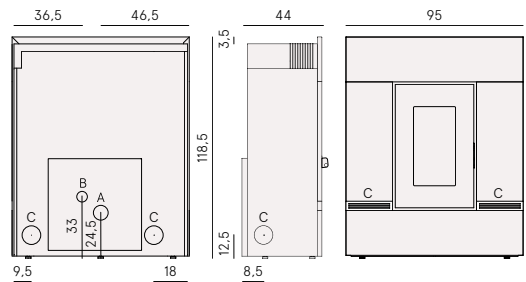

White Steel	Light Bronze Steel	Titanium Steel
Red Steel	Anthracite Steel	Serpentino Stone

12 kW	13.3 kW	108 m³ 342 m³	23 kg	8 h 27 h	0,86 kg/h 3,0 kg/h	90 %
93,5 %	3,8 kW	161/191 kg	Pellet ø 6 mm	ø 80 mm	ø 60 mm	ø 80 mm

European standards Art. BImSchV 2015 Regensburg München Stuttgart Aachen EN 14785:2006 **CE** Certificate model name: MITHOS PLUS 12 PS



Mithos Plus 14 Ps ● 14 kW

P. 60



Scopri le **caratteristiche** e il risparmio del **conto termico**

A+

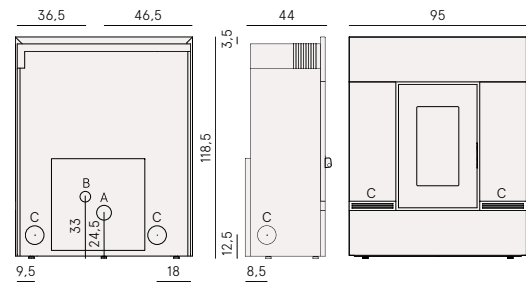

White Steel	Light Bronze Steel	Titanium Steel
Red Steel	Anthracite Steel	Serpentino Stone

14 kW	15.7 kW	108 m³ 399 m³	23 kg	7 h 27 h	0,86 kg/h 3,5 kg/h	89 %
93,5 %	3,8 kW	161/191 kg	Pellet ø 6 mm	ø 80 mm	ø 60 mm	ø 80 mm

European standards Art. 15A B-VG 2015 BImSchV 2015 Regensburg München Stuttgart Aachen EN 14785:2006 **CE** Certificate model name: MITHOS PLUS 14 PS



Mithos Plus 12 Up-Twin ● 12 kW P. 60

● 12 kW P. 60



Scopri le **caratteristiche** e il risparmio del **conto termico**

A+

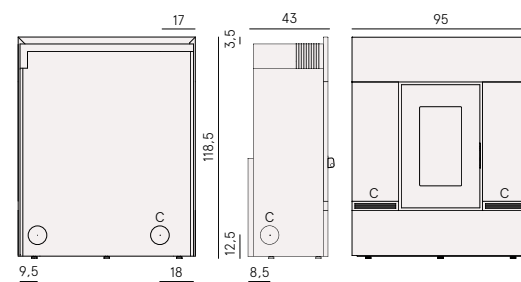

White Steel	Light Bronze Steel	Titanium Steel
Red Steel	Anthracite Steel	Serpentino Stone

12 kW	13.3 kW	108 m³ 342 m³	23 kg	8 h 27 h	0,86 kg/h 3,0 kg/h	90 %
93,5 %	3,8 kW	165/195 kg	Pellet ø 6 mm	ø 80 mm	ø 130 mm	ø 80 mm

European standards BImSchV 2015 Regensburg München Stuttgart Aachen EN 14785:2006 **CE** Certificate model name: MITHOS3 PLUS 12



Mithos Plus 14 Up-Twin ● 14 kW P. 60

● 14 kW P. 60



Scopri le **caratteristiche** e il risparmio del **conto termico**

A+

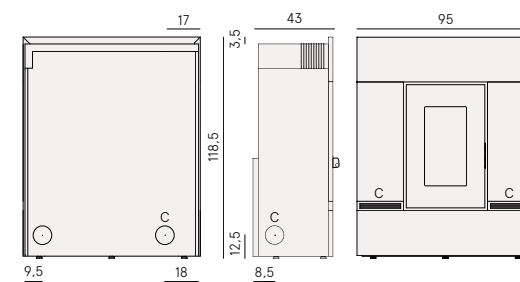

White Steel	Light Bronze Steel	Titanium Steel
Red Steel	Anthracite Steel	Serpentino Stone

14 kW	15.7 kW	108 m³ 399 m³	23 kg	7 h 27 h	0,86 kg/h 3,5 kg/h	89 %
93,5 %	3,8 kW	165/195 kg	Pellet ø 6 mm	ø 80 mm	ø 130 mm	ø 80 mm

European standards Art. 15A B-VG 2015 BImSchV 2015 Regensburg München Stuttgart Aachen EN 14785:2006 **CE** Certificate model name: MITHOS3 PLUS 14



Atena Plus 12 ● 12 kW

P. 62



Scopri le caratteristiche e il risparmio del conto termico

A+

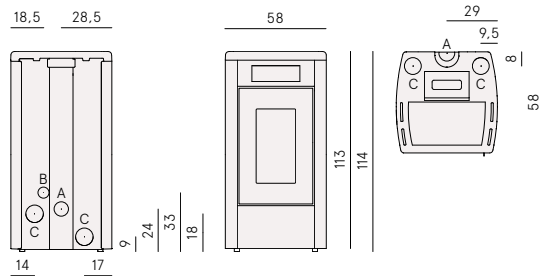

White Majolica	Ivory Majolica	Red Majolica	White Steel
Ivory Steel	Red Steel	Titanium Steel	Anthracite Steel

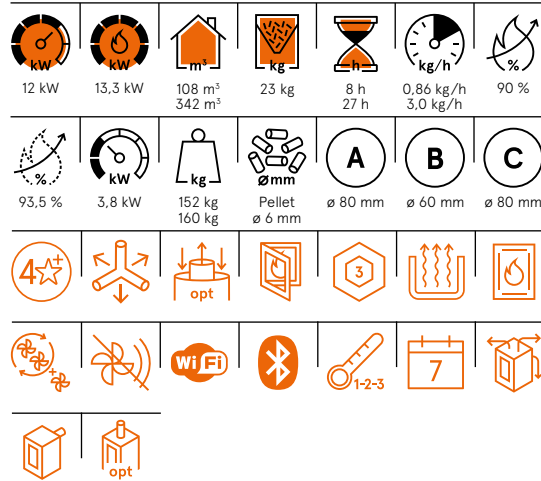

European standards BImSchV 2015 Regensburg München
Stuttgart Aachen EN 14785:2006
CE Certificate model name: ATENA3 PLUS 12



Atena Plus 14 ● 14 kW

P. 62



Scopri le caratteristiche e il risparmio del conto termico

A+

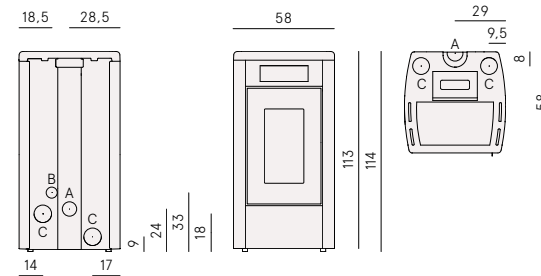

White Majolica	Ivory Majolica	Red Majolica	White Steel
Ivory Steel	Red Steel	Titanium Steel	Anthracite Steel

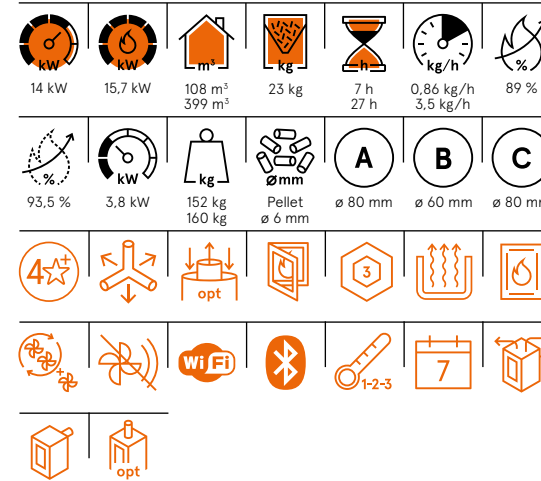

European standards Art. 15A B-VG 2015 BImSchV 2015 Regensburg
München Stuttgart Aachen EN 14785:2006
CE Certificate model name: ATENA3 PLUS 14



Pellet Hydro

La soluzione ideale per chi vuole scaldare anche i termosifoni e raggiungere un calore confortevole ed uniforme in tutta la casa

The ideal solution for customers who also want to heat radiators and enjoy a cosy temperature with evenly distributed heat throughout the house

La solution idéale pour chauffer aussi les radiateurs et obtenir une chaleur confortable et uniforme dans toute la maison

Die ideale Lösung, wenn auch die Heizkörper beheizt werden sollen und im gesamten Haus eine komfortable, gleichmäßige Wärme gewünscht ist

Idro Prince 12 ● 11,8 kW

P. 64



Scopri le caratteristiche e il risparmio del conto termico

A+

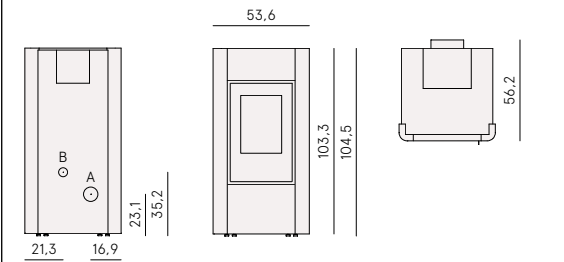

White Steel	Light Bronze Steel	Titanium Steel
Red Steel	Anthracite Steel	

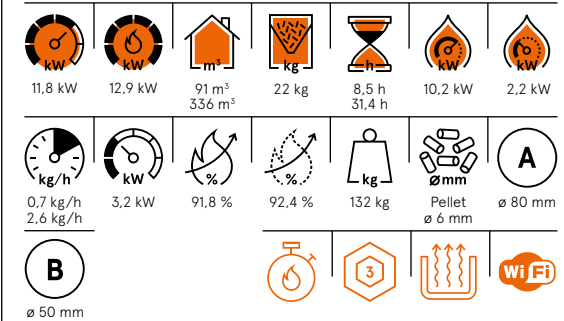

European standards Art. 15A B-VG 2015 BImSchV 2015 Regensburg
München Stuttgart Aachen EN 14785:2006
CE Certificate model name: IDRO PRINCE3 12



River Idrotech 18 ● 17,7 kW

P. 66



Scopri le caratteristiche e il risparmio del conto termico

A++

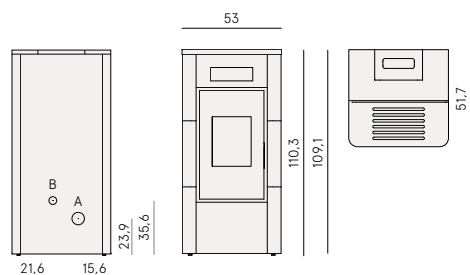

White Steel	Light Bronze Steel	Titanium Steel	Anthracite Steel
Red Majolica	White Majolica	Ivory Majolica	

European standards Art. BimSchV 2015 Regensburg München Stuttgart Aachen EN 14785:2006 **CE** Certificate model name: RIVER IDROTECH 18 T1



River Idrotech 24/24 H₂O ● 24,2 kW

P. 66



Scopri le caratteristiche e il risparmio del conto termico

A++

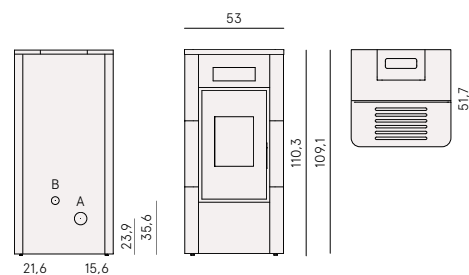

White Steel	Light Bronze Steel	Titanium Steel	Anthracite Steel
Red Majolica	White Majolica	Ivory Majolica	

European standards Art. BimSchV 2015 Regensburg München Stuttgart Aachen EN 14785:2006 **CE** Certificate model name: RIVER IDROTECH 24 T1 RIVER IDROTECH 24 H2O T1



River Idro 16 ● 16,1 kW

P. 66



Scopri le caratteristiche e il risparmio del conto termico

A++

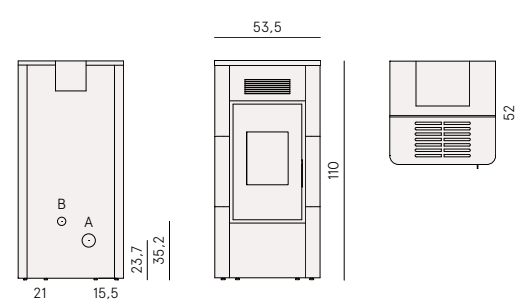

White Majolica	Ivory Majolica	Red Majolica	White Steel
Light Bronze Steel	Red Steel	Titanium Steel	Anthracite Steel

European standards BimSchV 2015 Regensburg München Stuttgart Aachen EN 14785:2006 **CE** Certificate model name: RIVER IDRO 16 T2



River Idro 23 ● 22,4 kW

P. 68



Scopri le caratteristiche e il risparmio del conto termico

A++

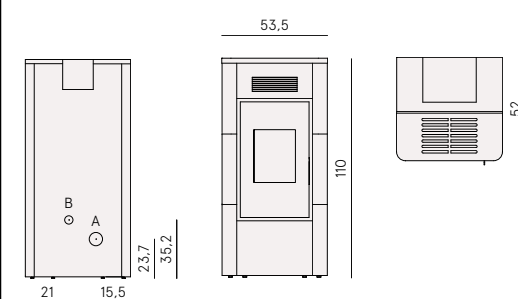

White Majolica	Ivory Majolica	Red Majolica	White Steel
Light Bronze Steel	Red Steel	Titanium Steel	Anthracite Steel

European standards BimSchV 2015 Regensburg München Stuttgart Aachen EN 14785:2006 **CE** Certificate model name: RIVER IDRO 23 T2



Saturno 16 ● 18 kW

P. 70



Scopri le **caratteristiche** e il risparmio del **conto termico**

A++

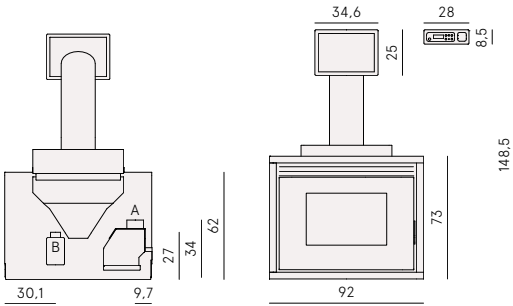

Black Steel

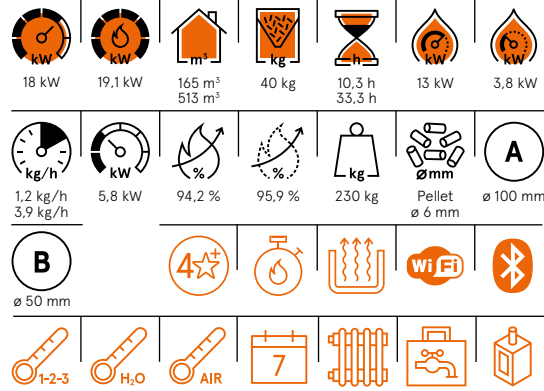

European standards BimSchV 2015 Regensburg München
Stuttgart Aachen EN 14785:2006
CE Certificate model name: SATURNO 16



Saturno 24 ● 24,7 kW

P. 70



Scopri le **caratteristiche** e il risparmio del **conto termico**

A++

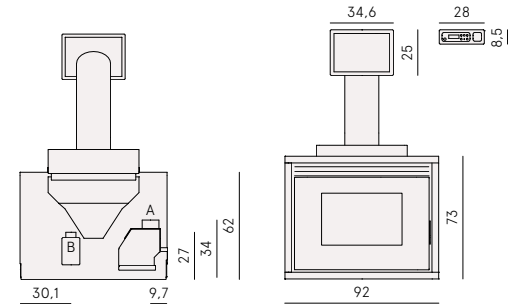

Black Steel

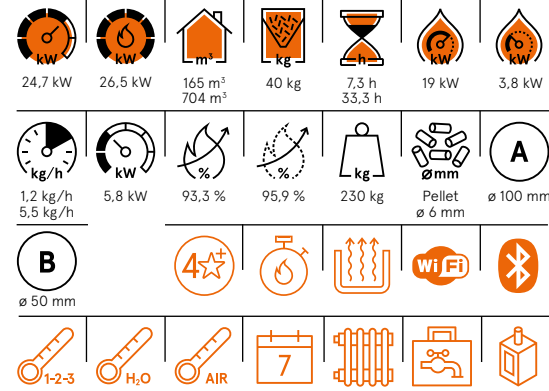

European standards BimSchV 2015 Regensburg München
Stuttgart Aachen EN 14785:2006
CE Certificate model name: SATURNO 24



Maya Idro 16 ● 16,1 kW

P. 72



Scopri le **caratteristiche** e il risparmio del **conto termico**

A++

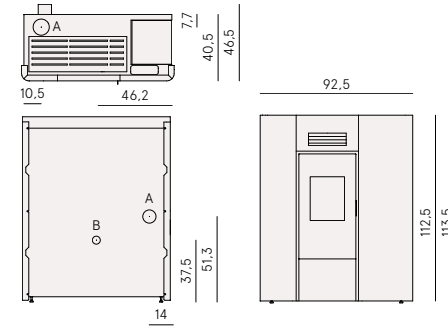

White Steel Light Bronze Steel Titanium Steel

Red Steel Anthracite Steel

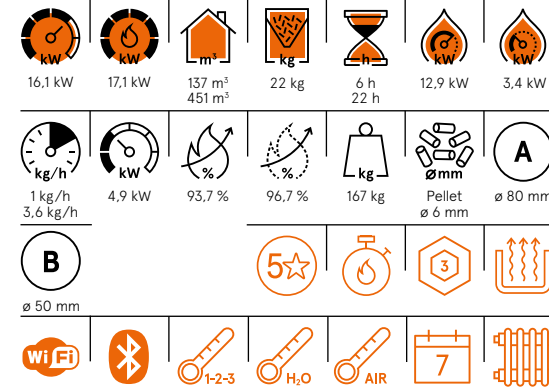

European standards BimSchV 2015 Regensburg München
Stuttgart Aachen EN 14785:2006
CE Certificate model name: MAYA IDRO 16 T2



Maya Idro 24 ● 22,4 kW

P. 72



Scopri le **caratteristiche** e il risparmio del **conto termico**

A++

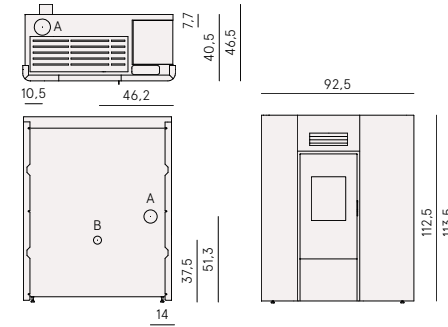

White Steel Light Bronze Steel Titanium Steel

Red Steel Anthracite Steel

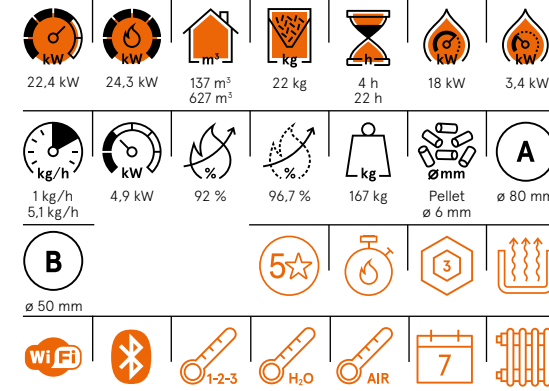

European standards BimSchV 2015 Regensburg München
Stuttgart Aachen EN 14785:2006
CE Certificate model name: MAYA IDRO 24 T2



Idro Prince 30 ● 28,6 kW

P. 74



Scopri le caratteristiche e il risparmio del conto termico

A+

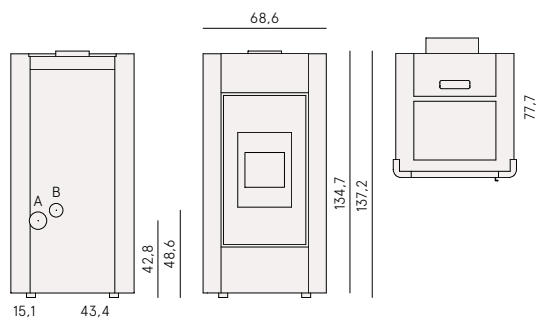

28,6 kW	30,6 kW	219 m ² 815 m ³	48 kg	7,6 h 28,2 h	26,9 kW	6,2 kW
1,7 kg/h 6,33 kg/h	7,7 kW	93,6 %	94,7 %	265 kg	Pellet ø 6 mm	A ø 100 mm
B ø 80 mm						
1-2-3	H ₂ O	7				

European standards BImSchV 2015 Regensburg München Stuttgart Aachen EN 14785:2006
 CE Certificate model name: IDRO PRINCE 30



Wood

Cucine economiche a legna a libera installazione e da incasso caratterizzate per unire il calore alla cottura

Free-standing and recessed wood-burning stoves that combine heat and cooking in one

Des cuisinières à bois à prix réduits, encastrables ou en pose libre pour cuisiner et chauffer en même temps

Holzherde, freistehend oder zum Einbau: Heizen und Kochen in einem

Smart 60 ● 6,5 kW

P. 76



Scopri le caratteristiche e il risparmio del conto termico

A+

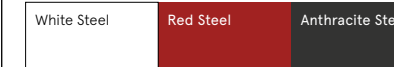
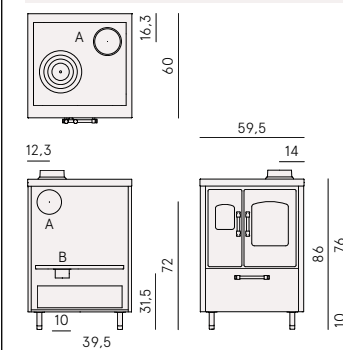

6,5 kW	7,7 kW	185 m ³	1,8 kg	85,1 %	L 24 cm P 42 cm H 29 cm	L 15 cm H 15 cm
I 4 cm	123 kg	L 30 cm	A ø 140 mm	B ø 80 mm		

European standards Art. 15A B-VG 2015 BImSchV 2015 Regensburg München Stuttgart Aachen EN 12815:2001/ EN 12004/AC:2007
 CE Certificate model name: SMART 60, SMART 60V, SMART 60S, SMART 60VS



Smart 80 ● 7,5 kW

P. 76



Scopri le caratteristiche e il risparmio del conto termico

A+

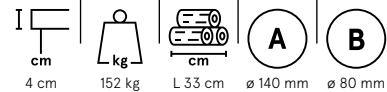
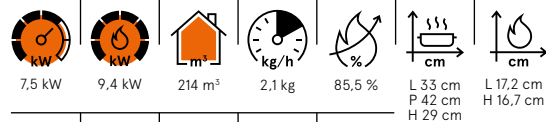
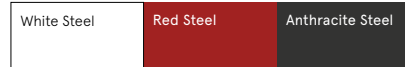
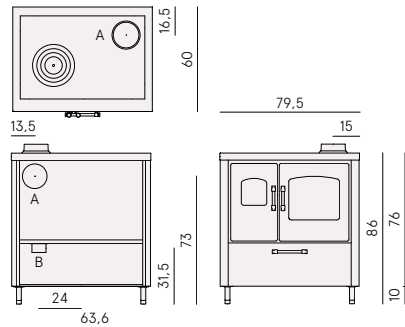

European standards BImSchV 2015 Regensburg München
Stuttgart Aachen EN 12815:2001/A1:2004/AC:2007

CE Certificate model name: SMART 80, SMART 80V, SMART 80VS



Kook 60 ● 6,2 kW

P. 78



Scopri le caratteristiche del prodotto

A+

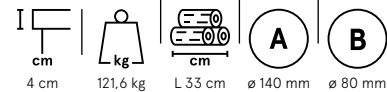
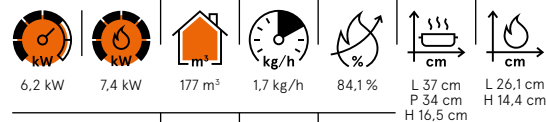
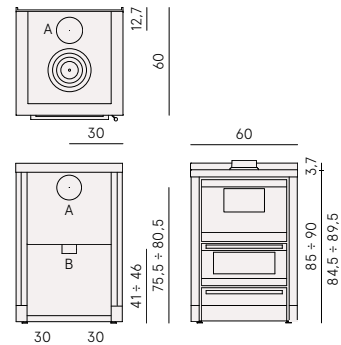

European standards Art. 15A B-VG 2015 BImSchV 2015 Regensburg München
Stuttgart Aachen EN 12815:2001/A1:2004/AC:2007

CE Certificate model name: KOOK60 4.0, KOOK60 4.0V



Kook 80 ● 7,5 kW

P. 78



Scopri le caratteristiche del prodotto

A+

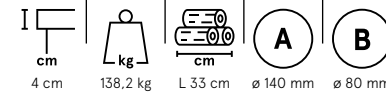
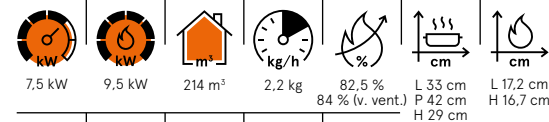
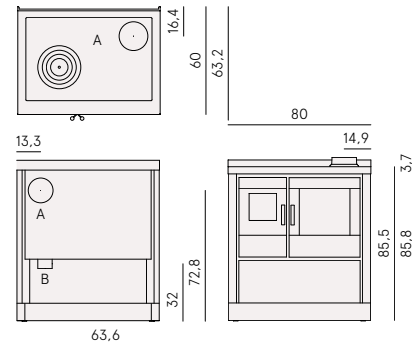

European standards Art. 15A B-VG 2015 BImSchV 2015 Regensburg München
Stuttgart Aachen EN 12815:2001/A1:2004/AC:2007

CE Certificate model name: KOOK80, KOOK80V



Kook 90 ● 7,5 kW

P. 78



Scopri le caratteristiche del prodotto

A+

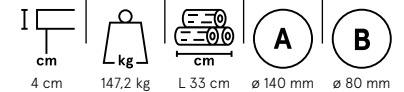
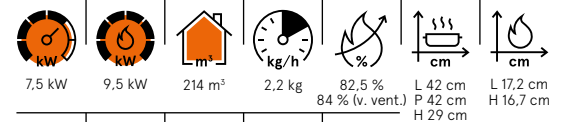
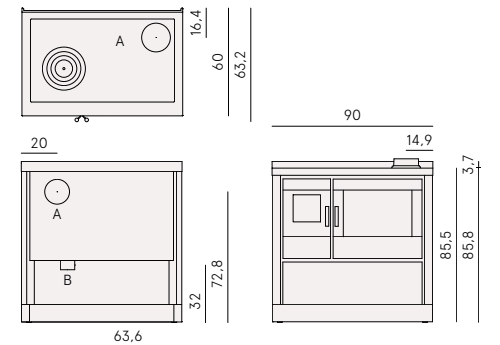

European standards Art. 15A B-VG 2015 BImSchV 2015 Regensburg München
Stuttgart Aachen EN 12815:2001/A1:2004/AC:2007

CE Certificate model name: KOOK90 4.0, KOOK90V 4.0

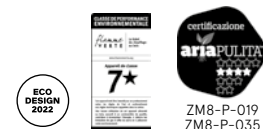

Graphic design
Metodo studio

Rendering
Alberto Rigo
e Metaverso

Printing
Imoco Group

Cadel S.r.l
Via Martiri della Libertà, 74
31025 Santa Lucia di Piave (TV)
Italy

cadelsrl.com